

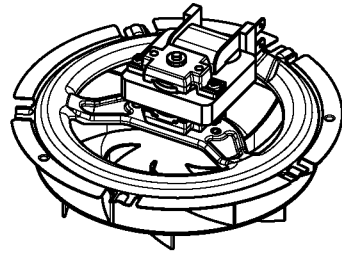

522

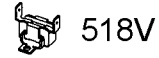

510V



518V

513A

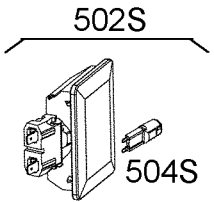

502S

504S

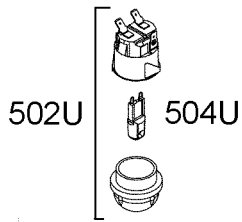

502U

504U

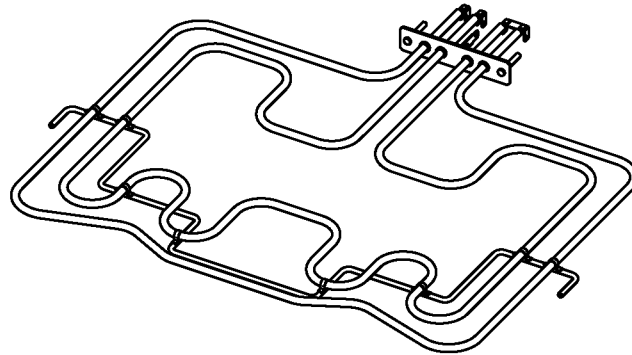

522A

500U



539



522C

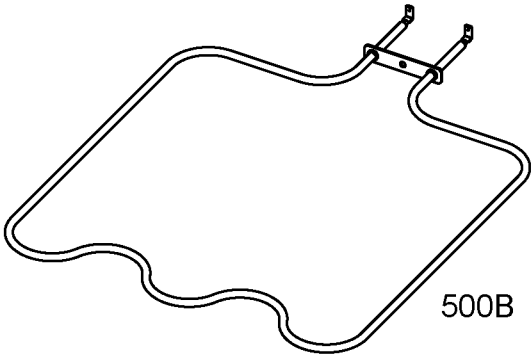

500B

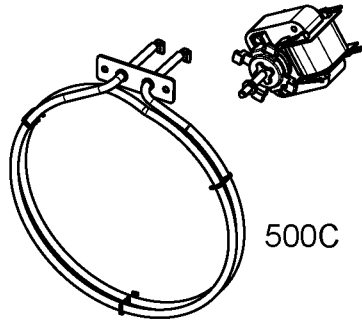

500C

510C

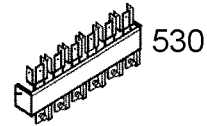

530

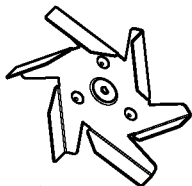

512

513