

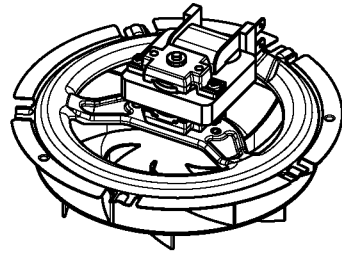

522

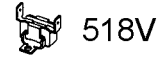

510V



518V

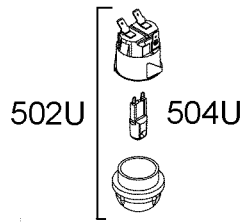

502U

504U

513A

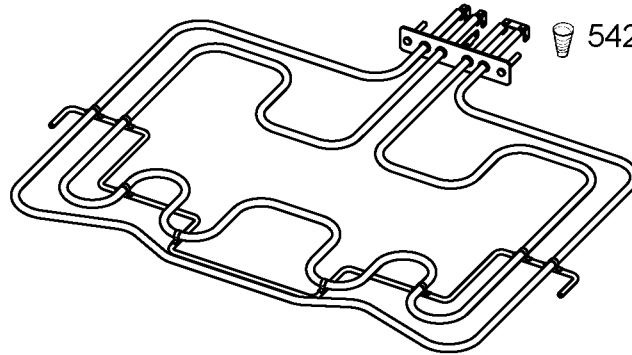

542G

500U



539



522C

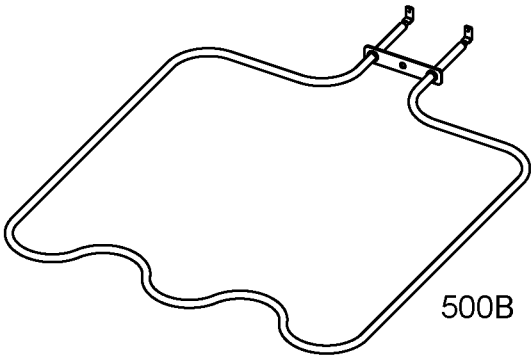

500B

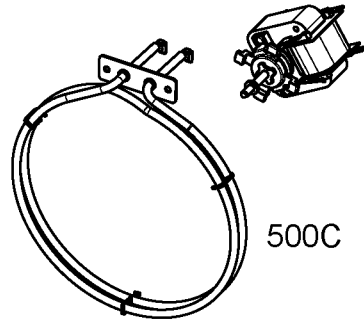

510C

500C

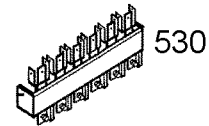

530

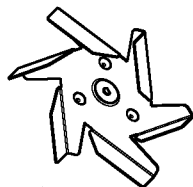

512

513