

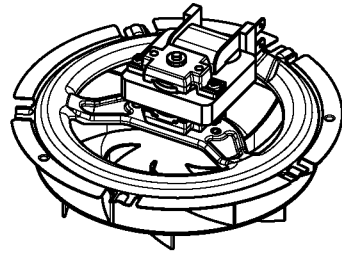

522



510V



518V

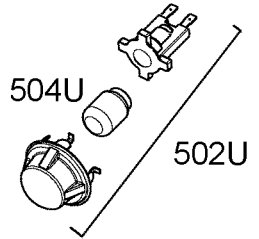

504U

502U

513A

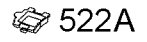

522A

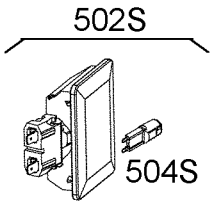

502S

504S

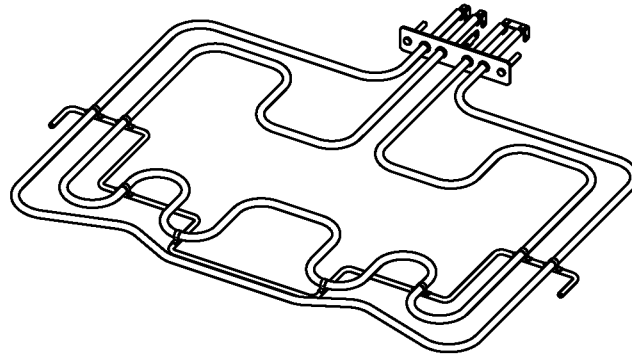

500U



522C

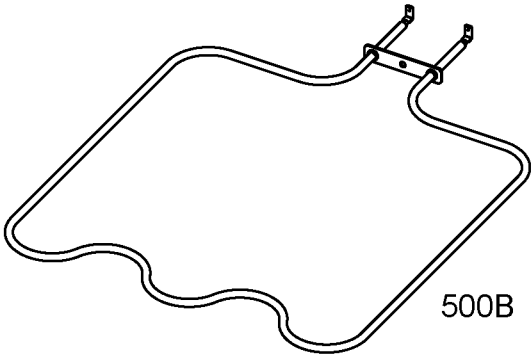

500B

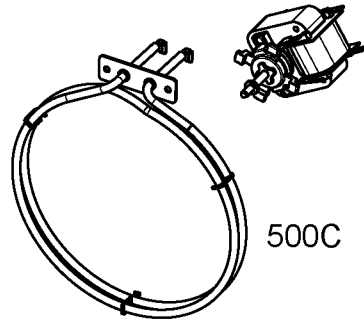

500C

510C

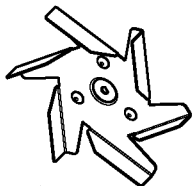

512

513

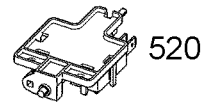

520