

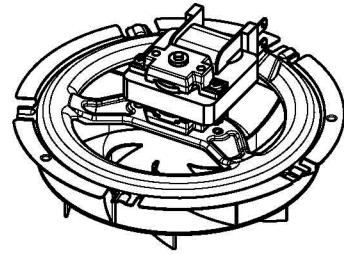

522



510V



518V

Ø 513A

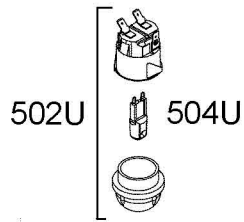

502U

504U



542G



540

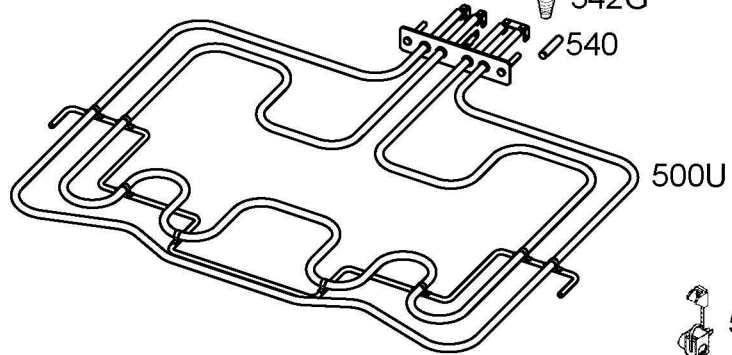

500U



522C

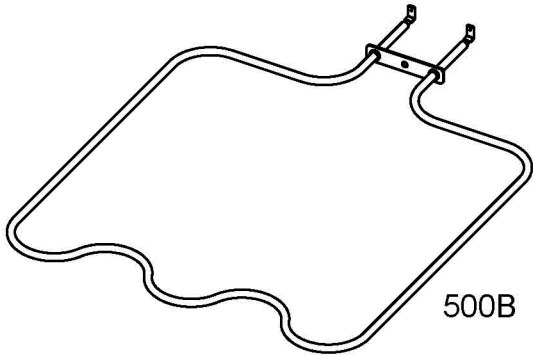

500B

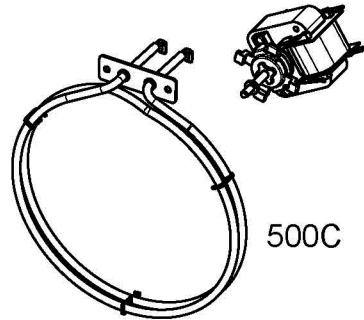

500C

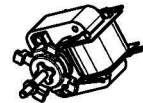

510C



530

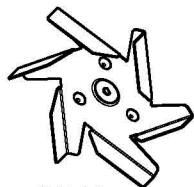

512

Ø 513