

CERAMIC HOT PLATE GROUP

57

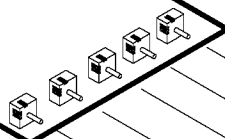

1049

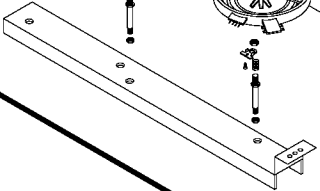
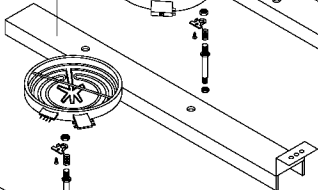
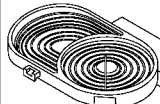
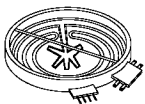
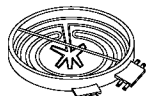

187

381

1265

606

482

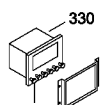

330

468

317

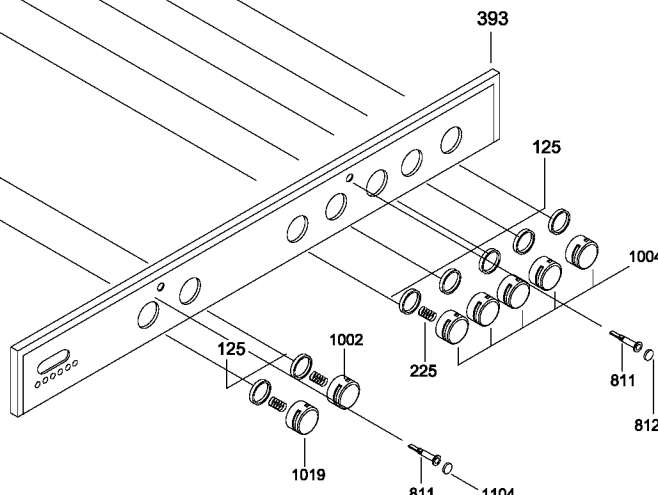

393

125

1004

811

812

125

1002

225

1019

811

1104