

305

315

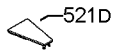
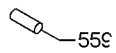

55C

521E

521A

530

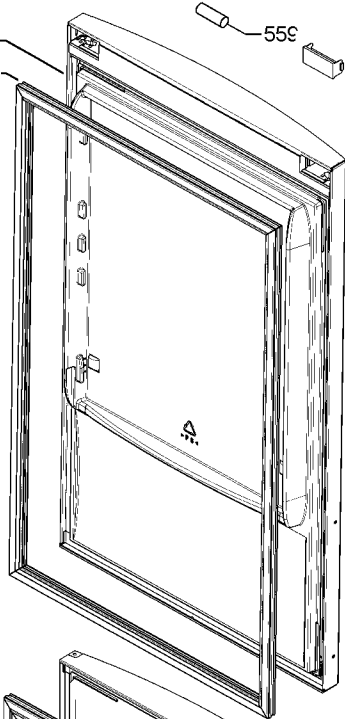
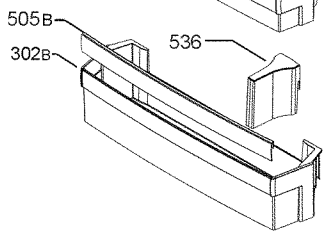
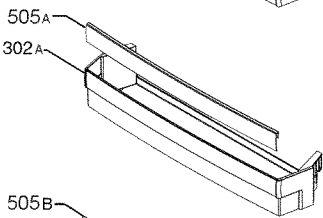
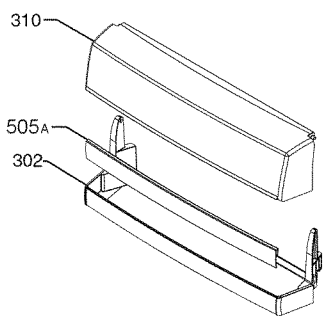

507

521F

521A

530A

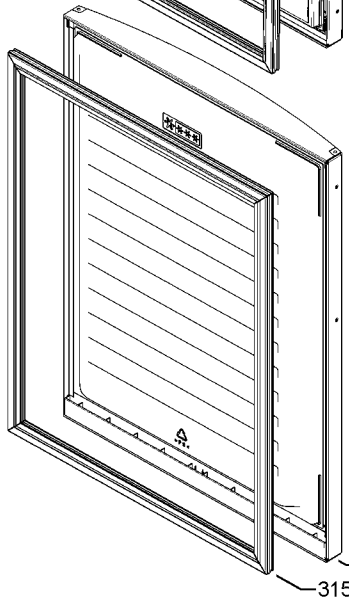

315A

305A