

538

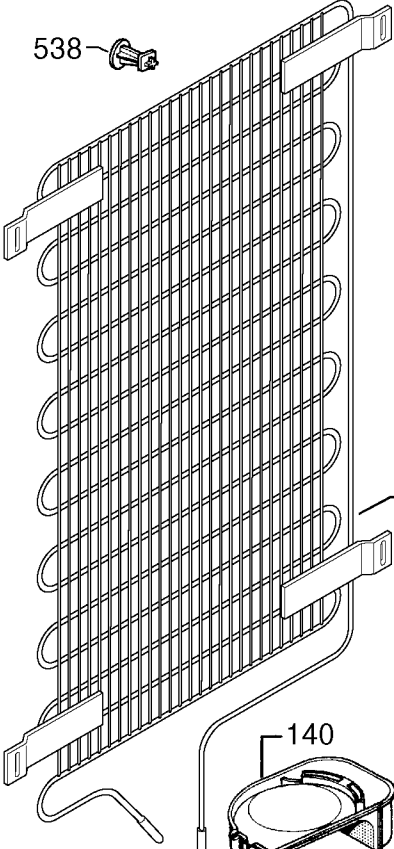

101



584

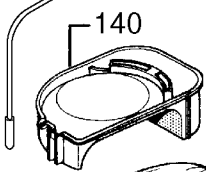

140

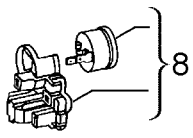

8



19

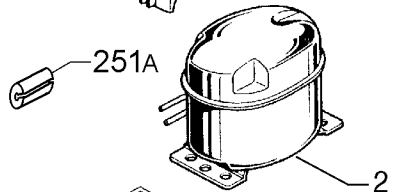

2

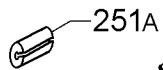

251A



567

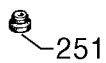

251

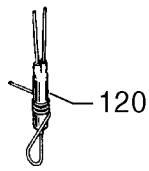

120