

305A

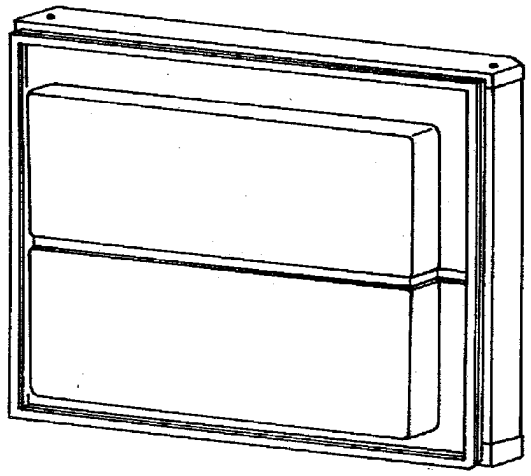

530
521

310



331



305

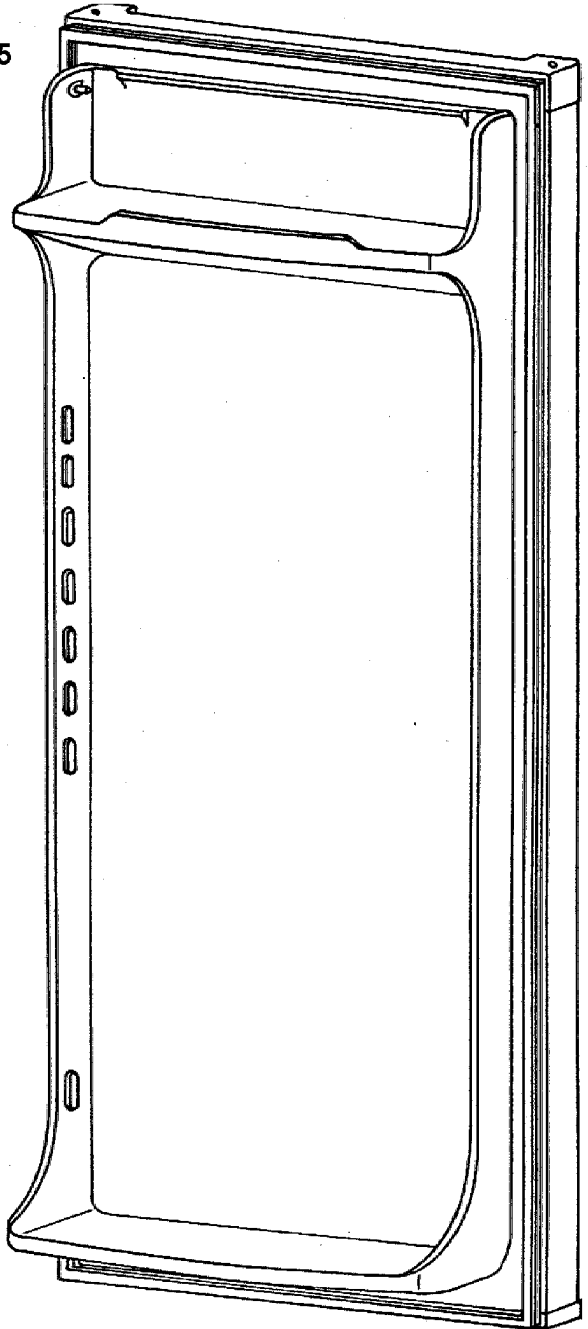

530
521

302A



302B

