

538

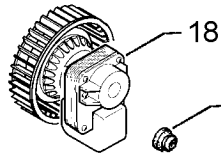

251c



18

251c

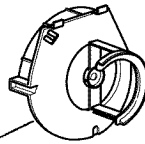

523



312

594

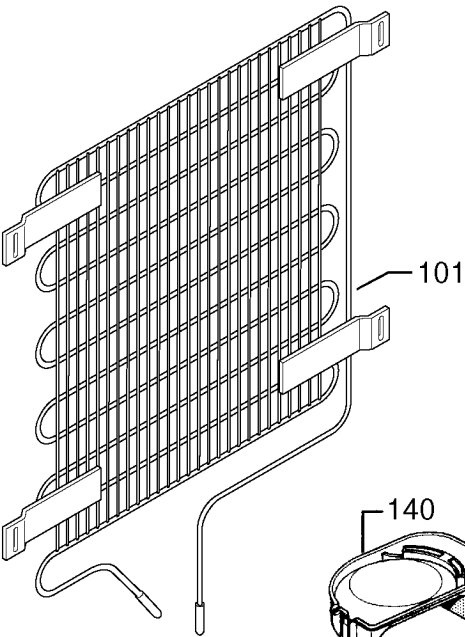
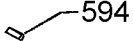

101

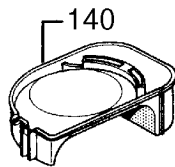

140

251A

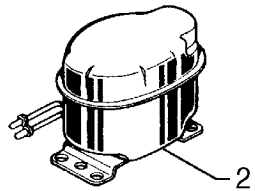

2

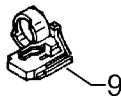

9

120



251

