

538

101

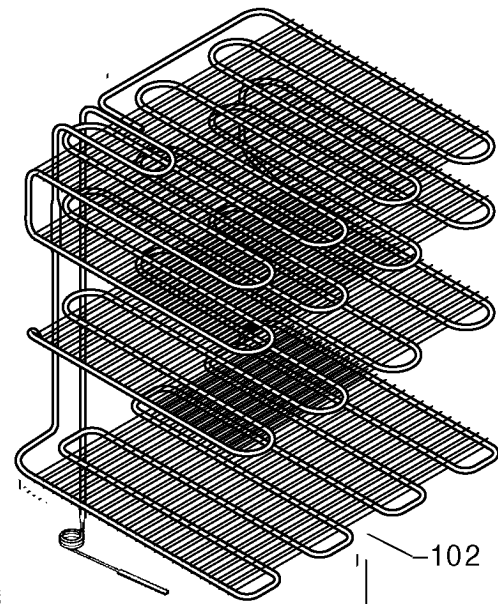

102

112

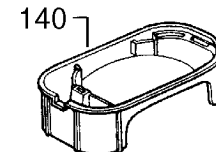

140

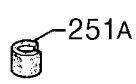

251A

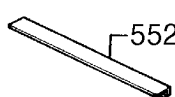

552

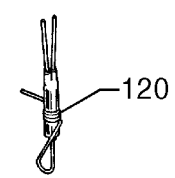

120



584

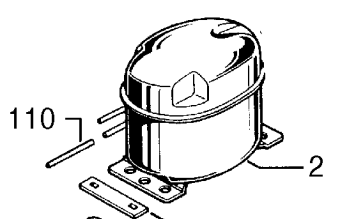

110

2

251

567

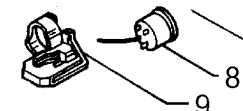

8

9