

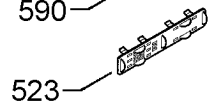

101

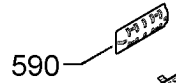

112

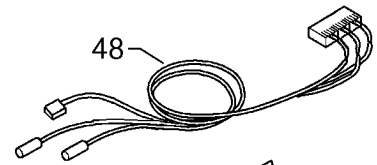
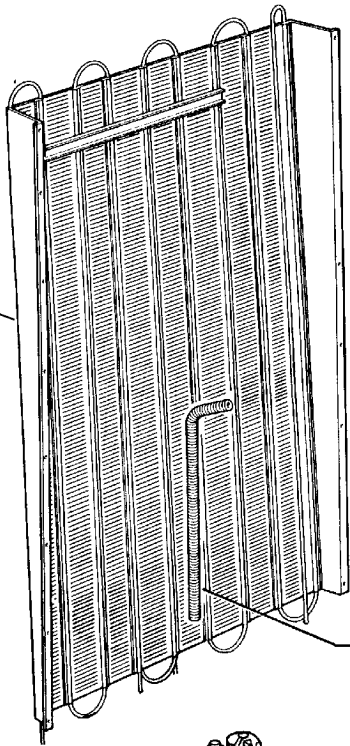
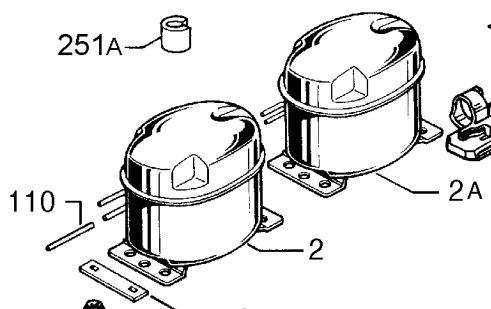
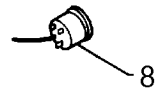
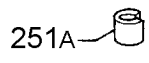
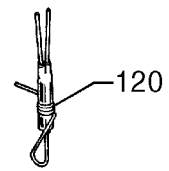
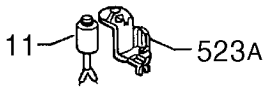
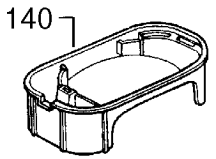

110

