

538

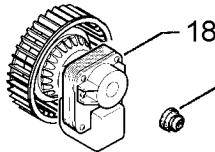

251c



251c

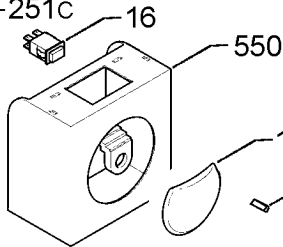

594

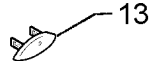

101

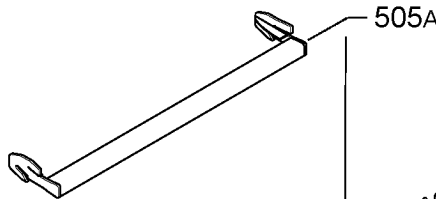
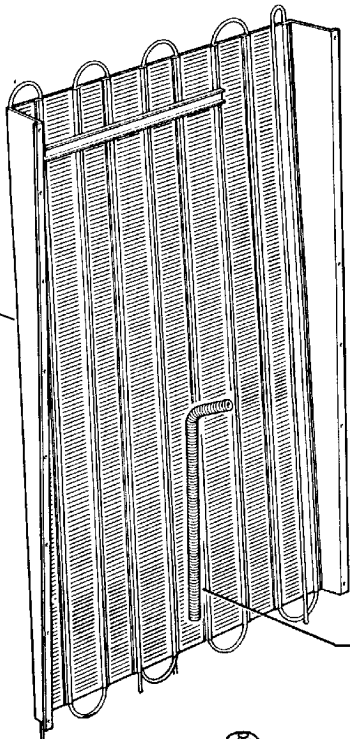

505A

112

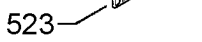

523

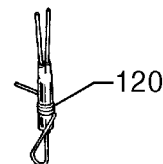

120



11

523A

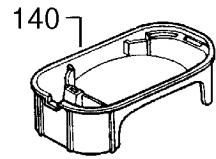

140



8



9

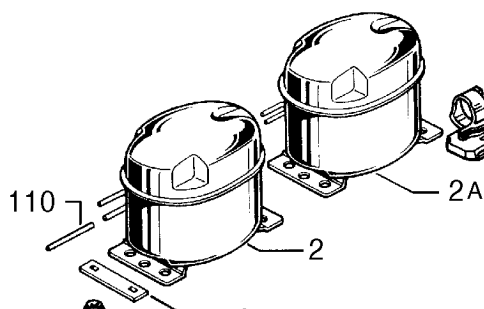

110

2

2A

251



9

567



584