

538

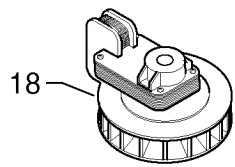

18

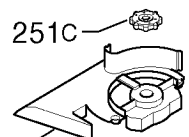

251C

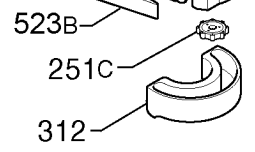

523B

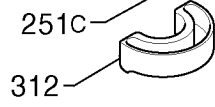

312

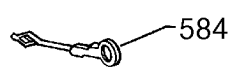

584

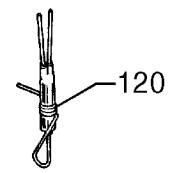

120

101

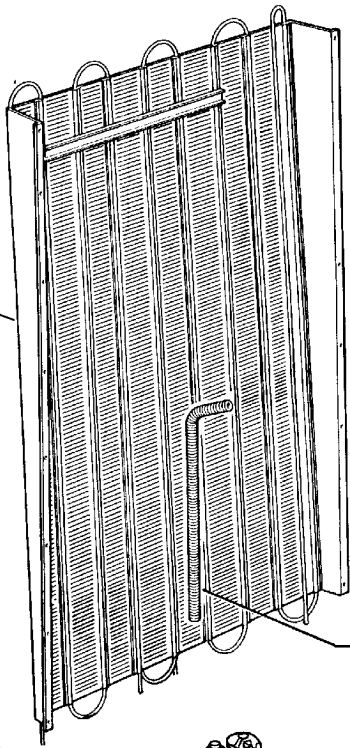

112

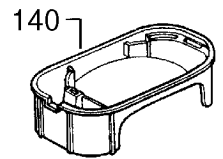

140

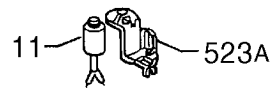

11



523A

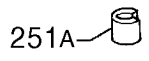

251A

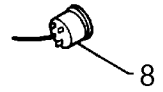

8



9

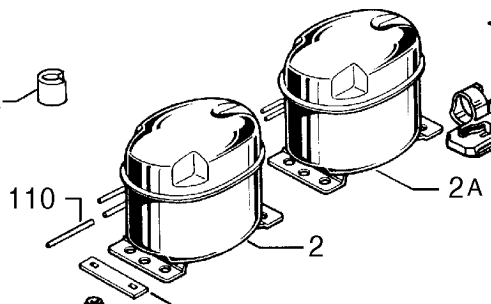

2A



110

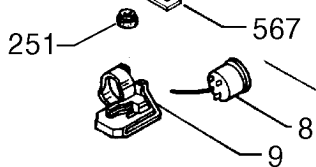

251

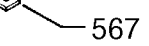

567

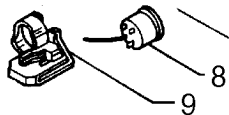

8

9