

37

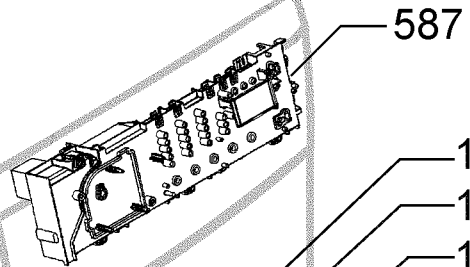

587

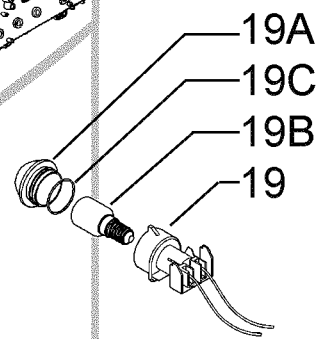

19A

19C

19B

19

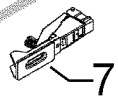

7

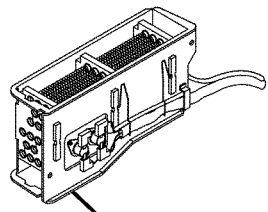

10

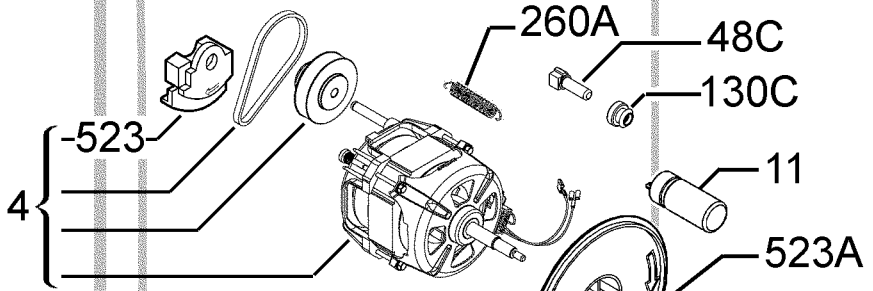

4

523

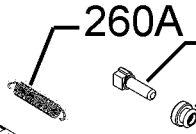

260A

48C

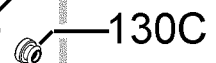

130C

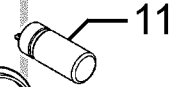

11

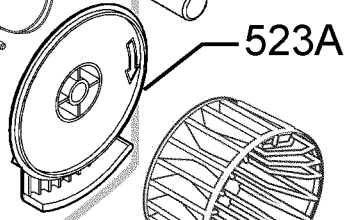

523A

159



522