

37

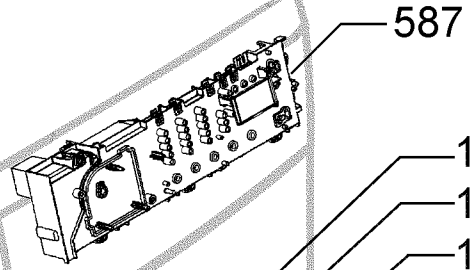

587

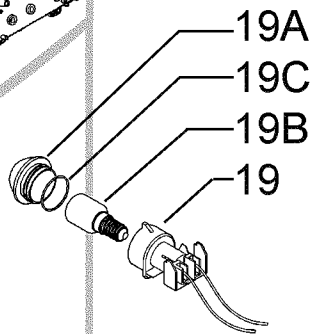

19A

19C

19B

19

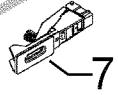

7

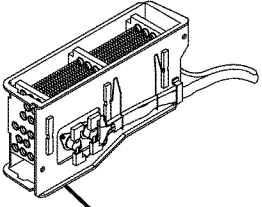

10

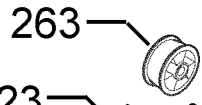

263

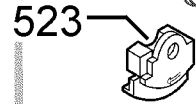

523

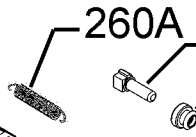

260A

48C

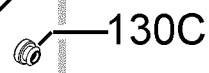

130C

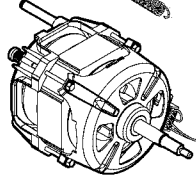

4

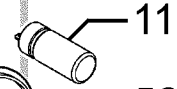

11

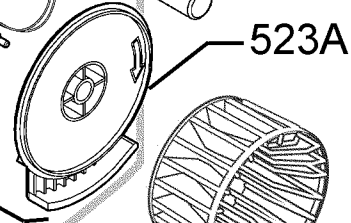

523A



522

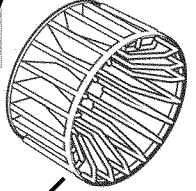

159