

344

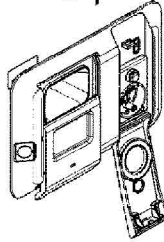

1187



587A

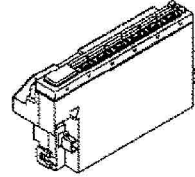

16

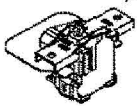

5877

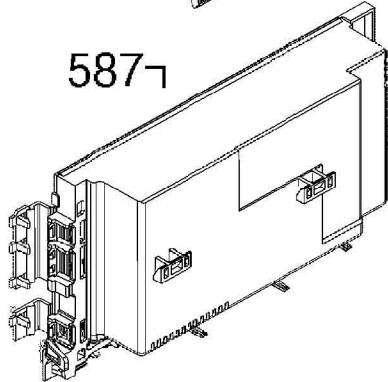

506

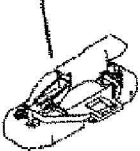

550C

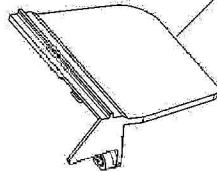

6

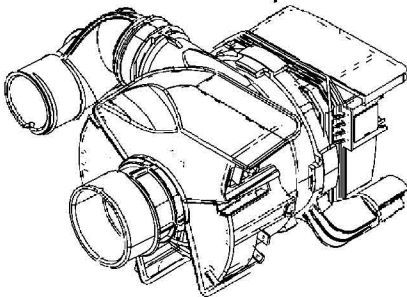

523G



12

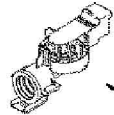

110C

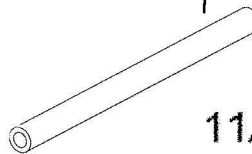

11A



11



48



567

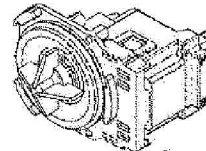

6A