

1187

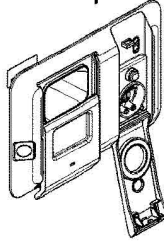

587A

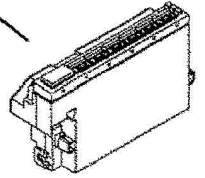

5877

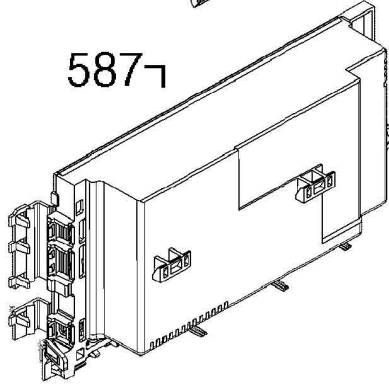

506



550C

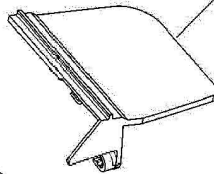

5

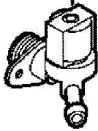

6

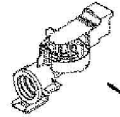
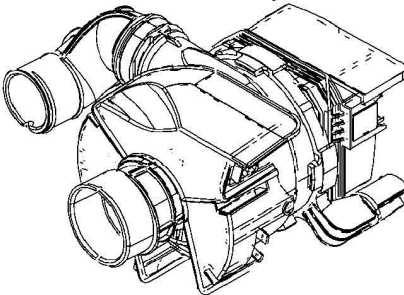

12

11A



11

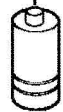

48



567



6A

