

118

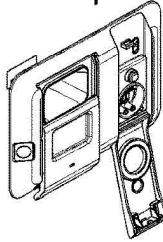

587A

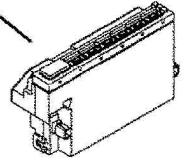

587

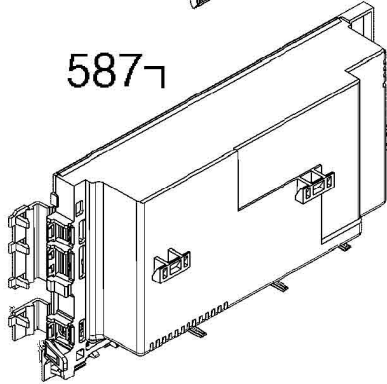

506

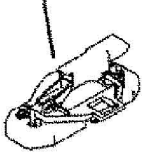

550C

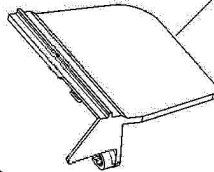

6

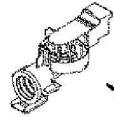
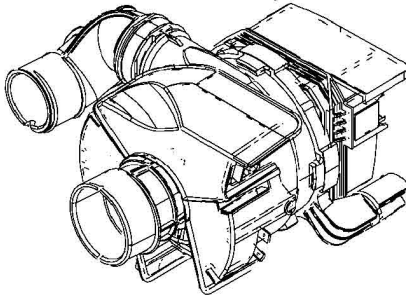

12

11A



11

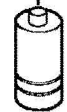

48



567



6A

