

344

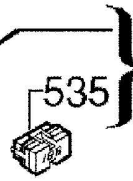

1187

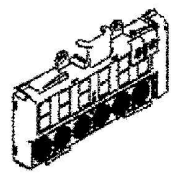
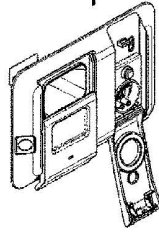

587A

16

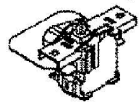

5877

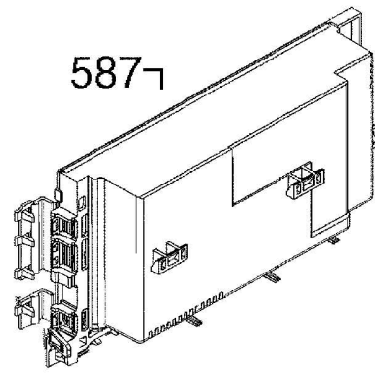

506

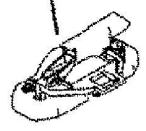

12

6

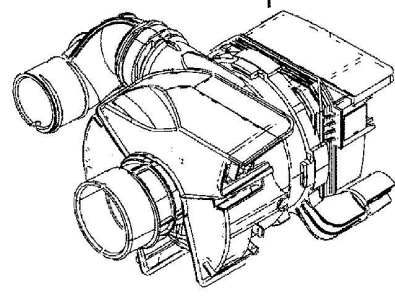

11

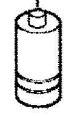

48



567

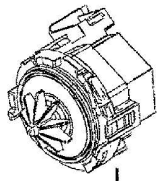

6A