

344

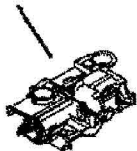

118

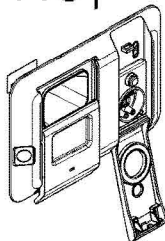

587A

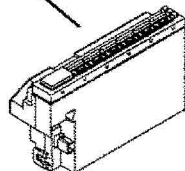

16

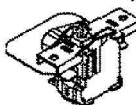

587

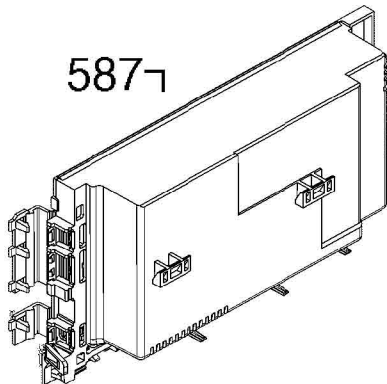

019

506



12

6

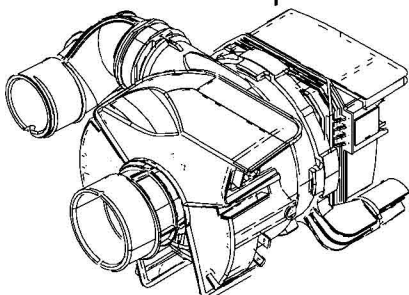

11



48



567

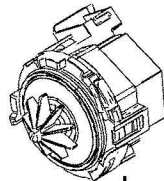

6A