

118

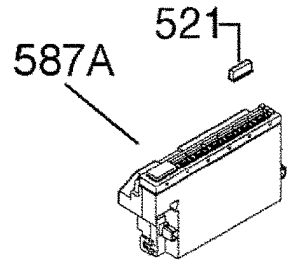

587

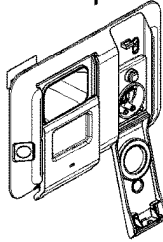
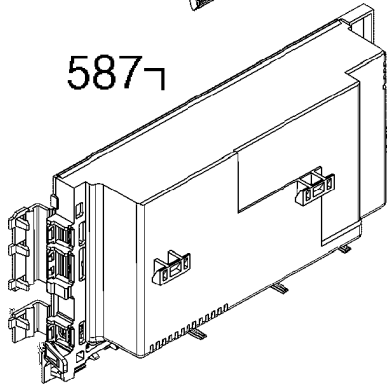

506

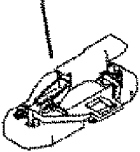

550C

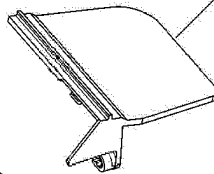

6

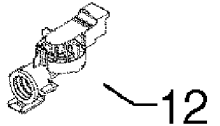
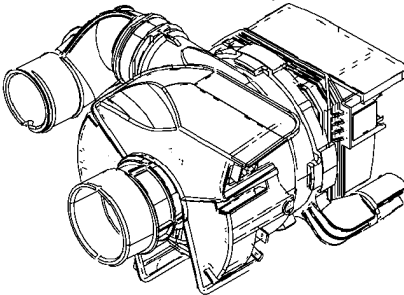

11A

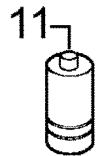

48



567



6A

