

344

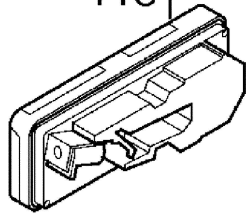

118



587A

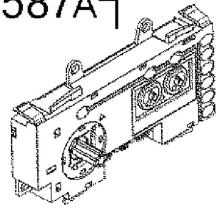

16

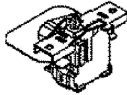

587

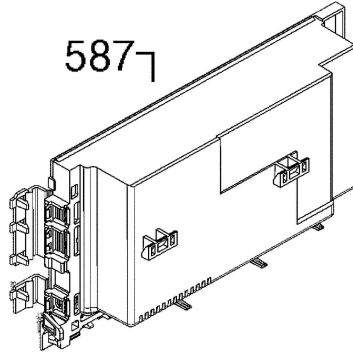

506



550C

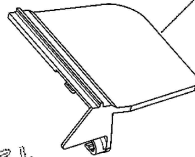

12



6

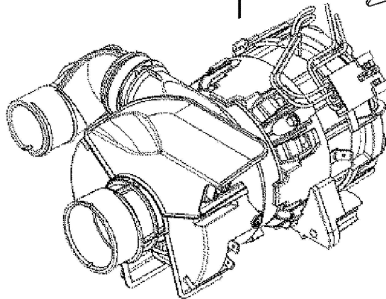

11A



48



567

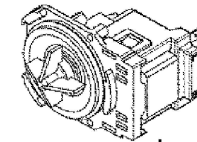
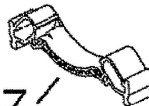

6A