

344

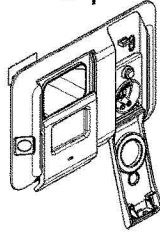

118



535

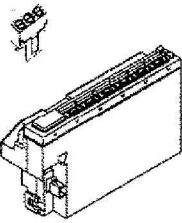

587A

16

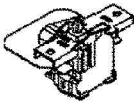

587

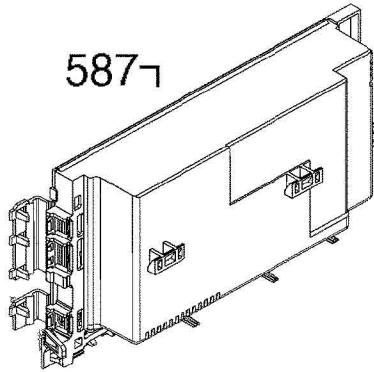

506

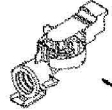

12

6

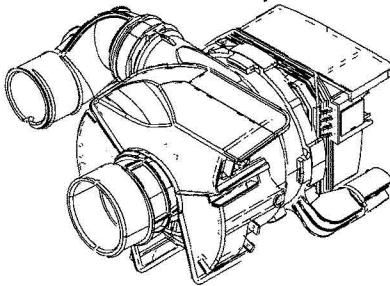

11

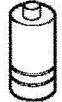

48



567

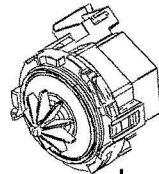

6A