

587A

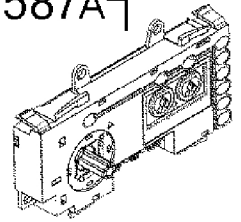

118

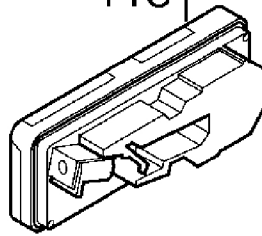

587

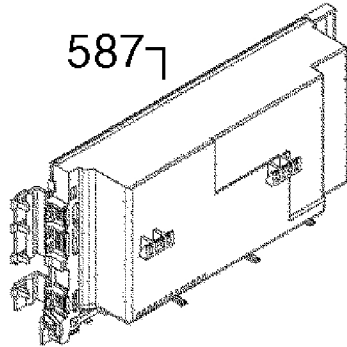

506



5



6

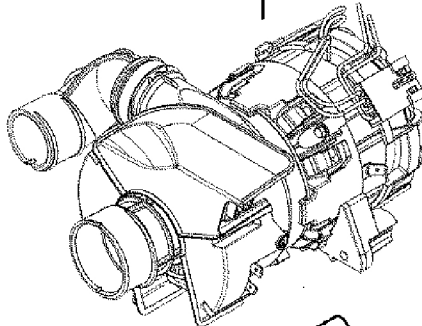

12

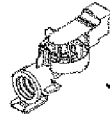

11A



48



567



6A

