

313

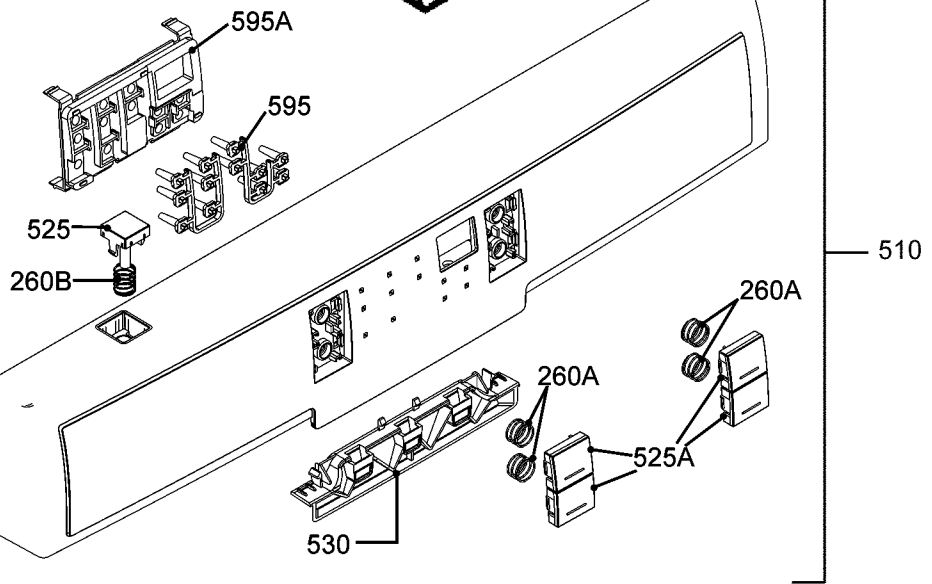

510