

240

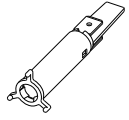

242

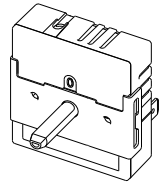

222D

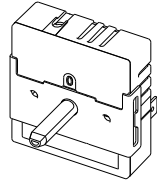

222S

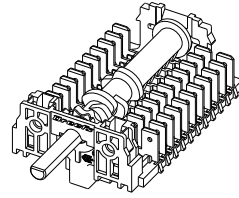

226

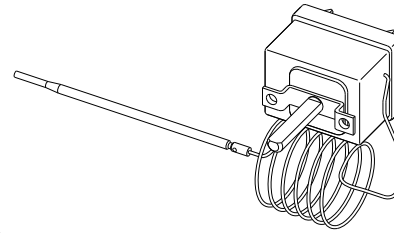

230

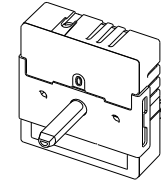

222D

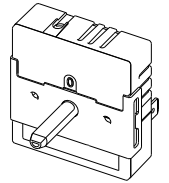

222S

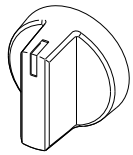

200

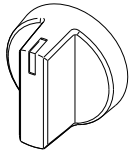

200

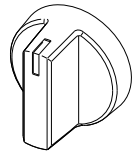

200

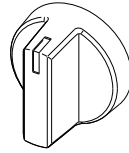

200

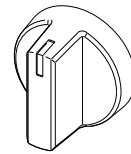

200



200

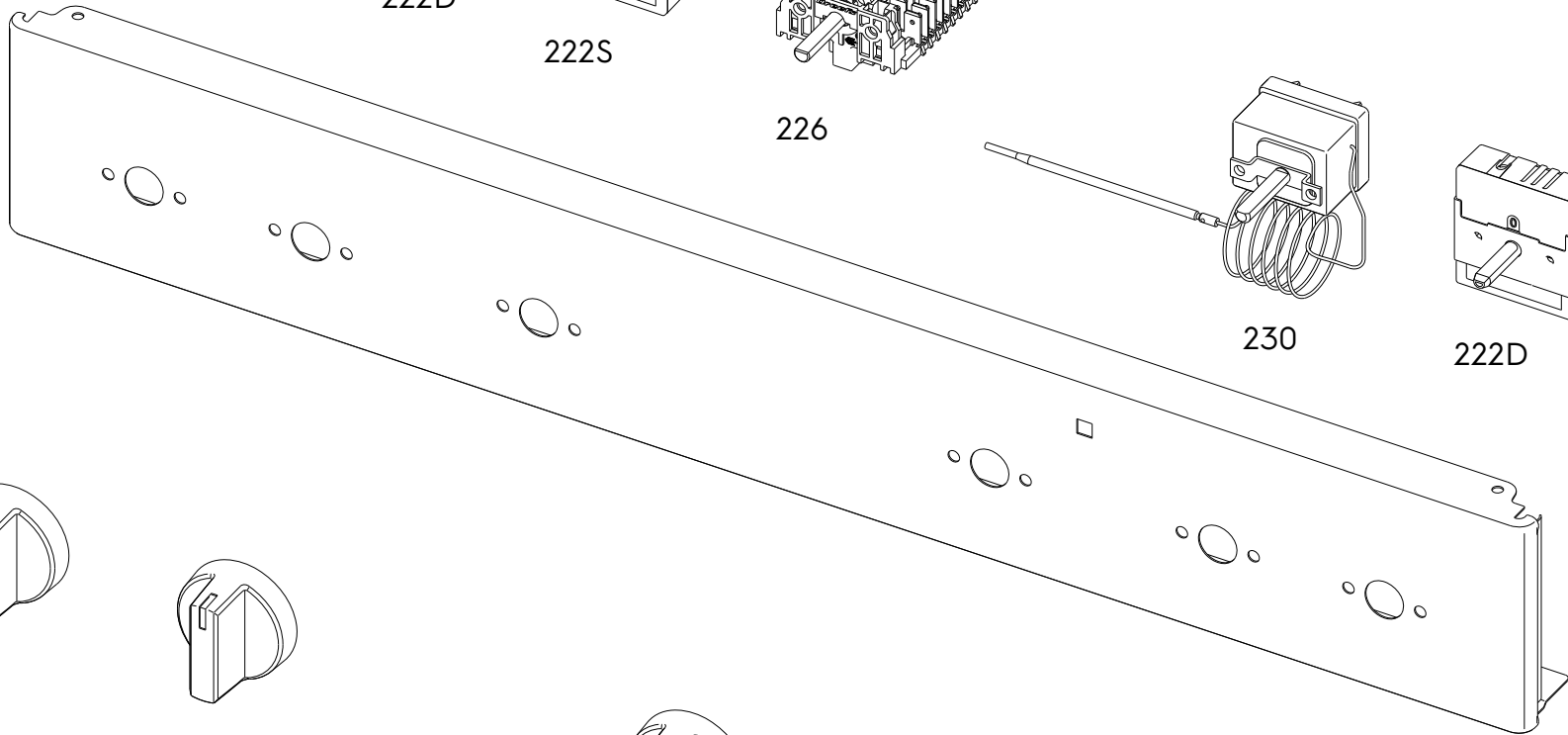

210

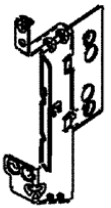

212A