

240

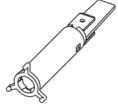

242

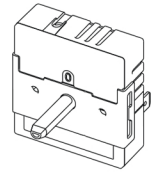
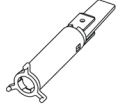

222D

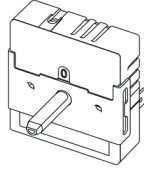

222S

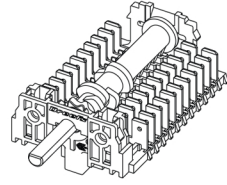

226

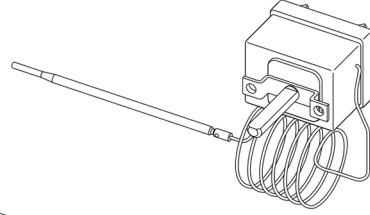

230

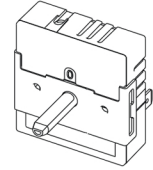

222D

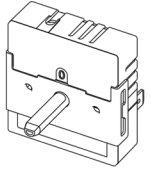

222S



200D



200S



200F

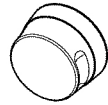

200T

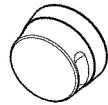

200D

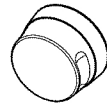

200S

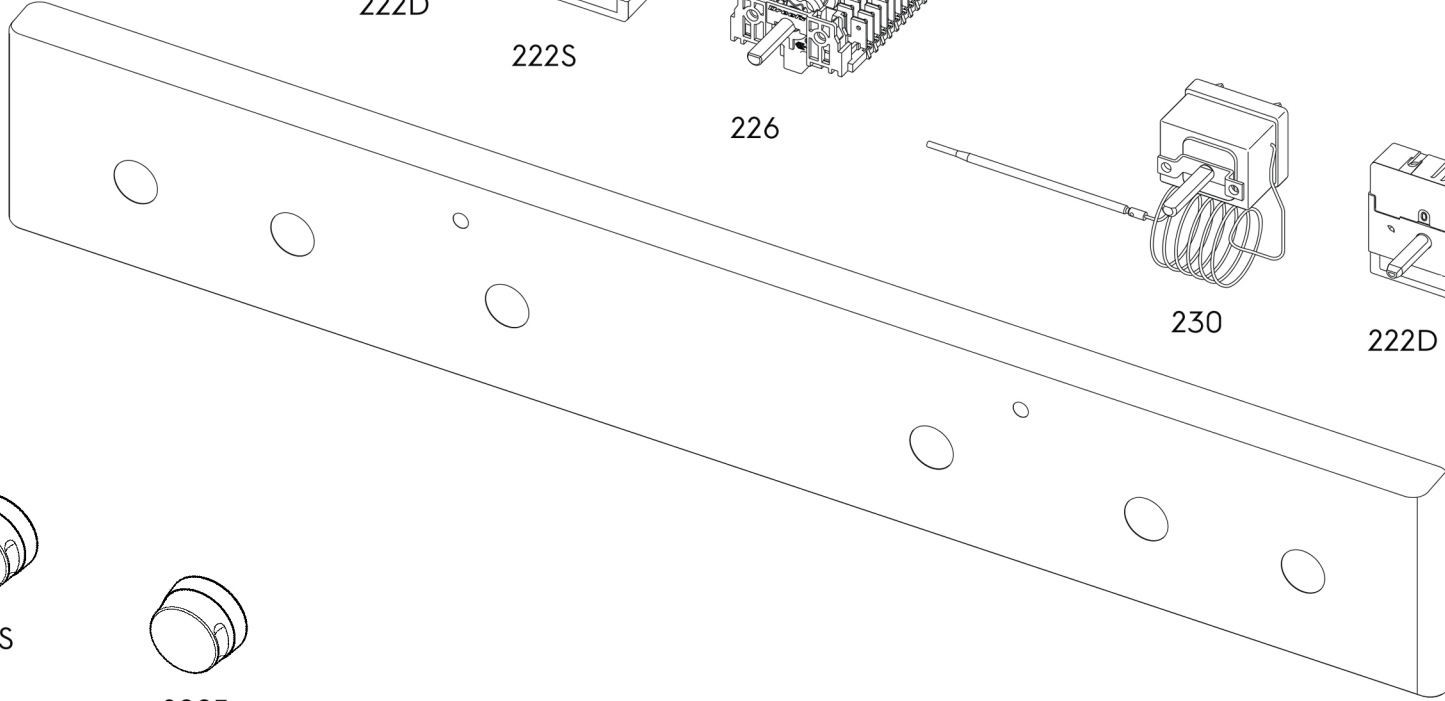

210

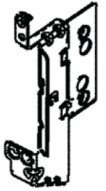

212A