

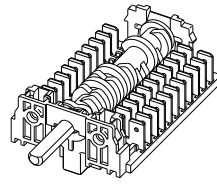

242

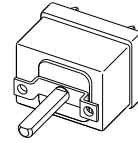

226U



230U

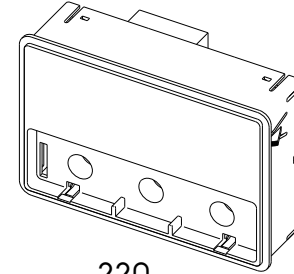

220

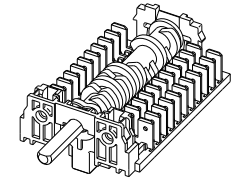

226L

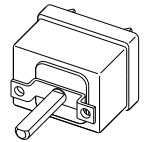

230L

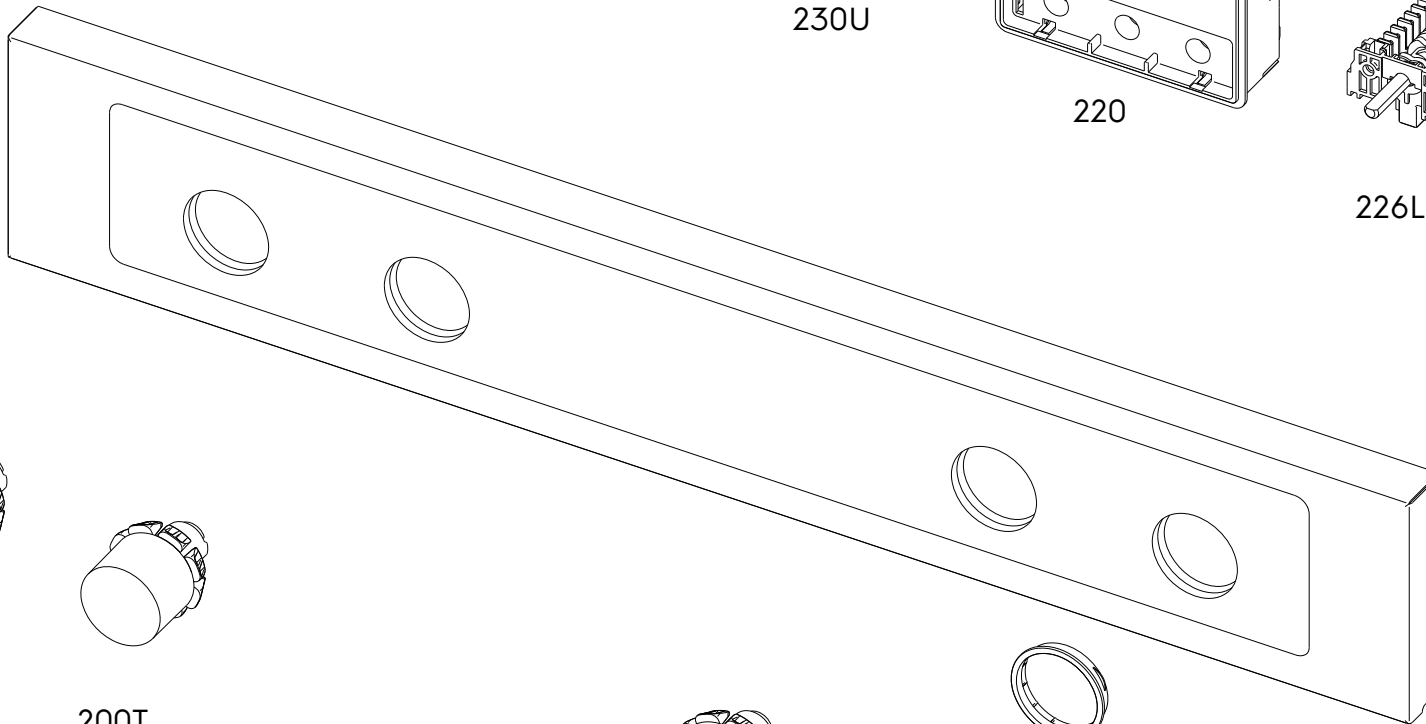

210

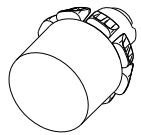

200F

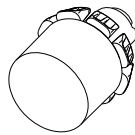

200T

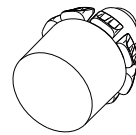

201F

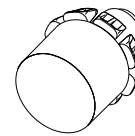

201T



202