

226

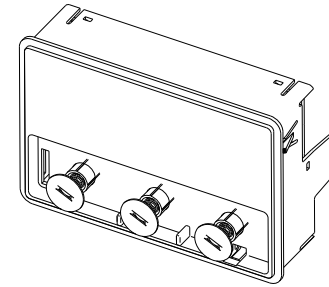

220

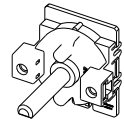

232

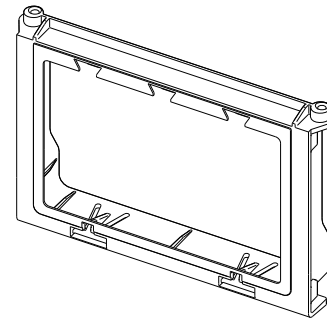

224

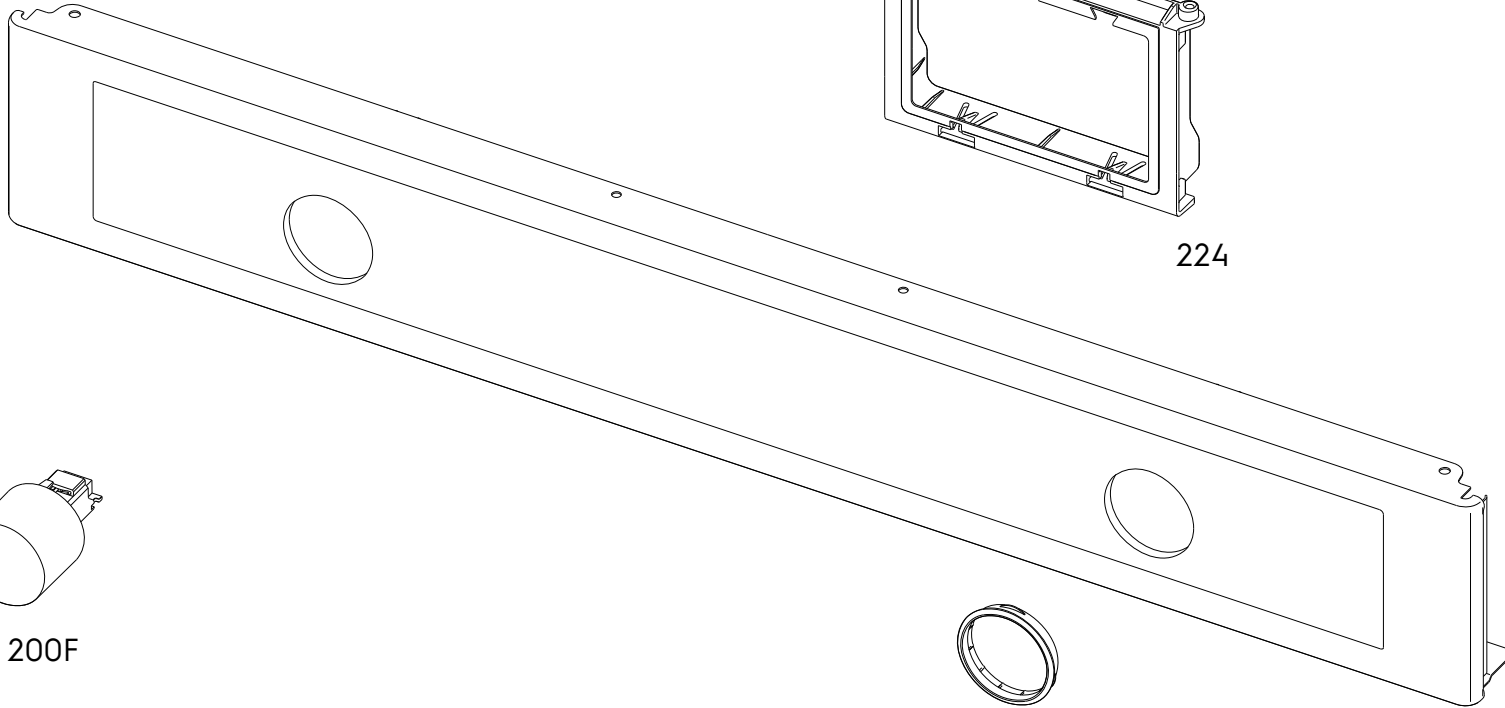

210

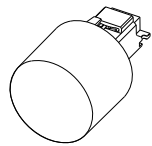

200F



202

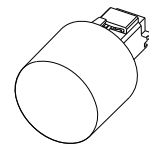

200T