

240

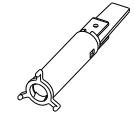

242

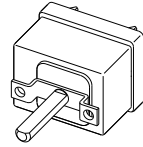

230

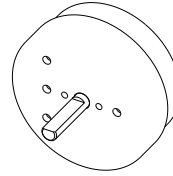

220

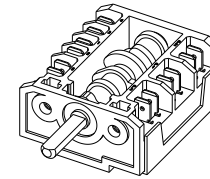

226

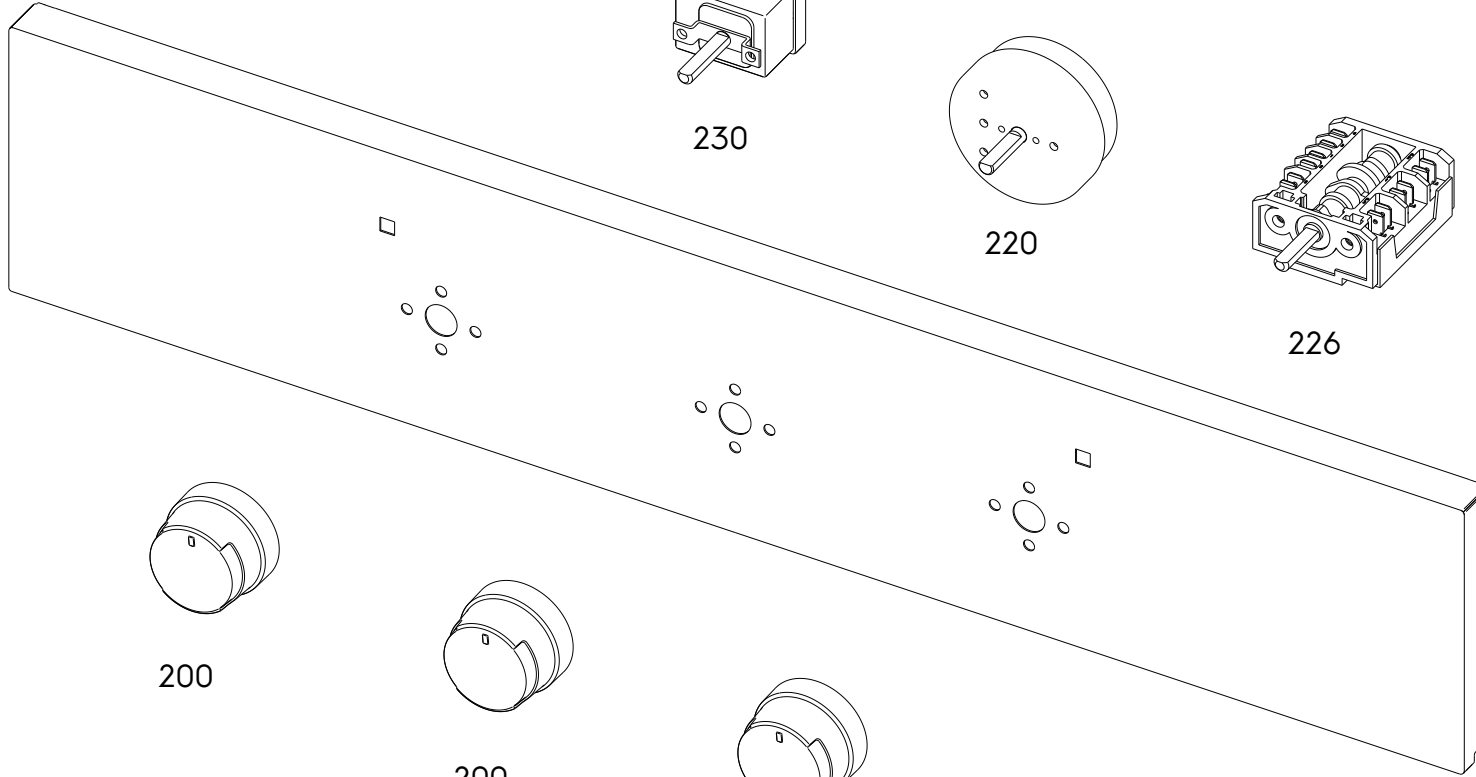

210

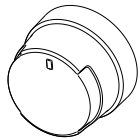

200

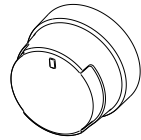

200

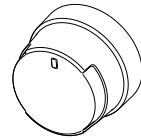

200

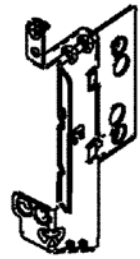

212A