

65

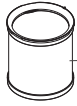

23

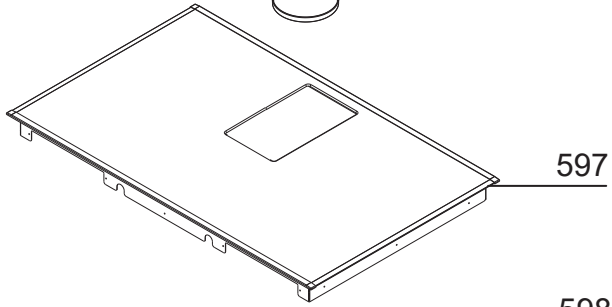

597



416

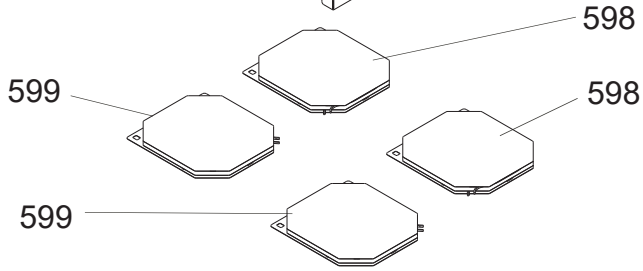

598

599

598

599

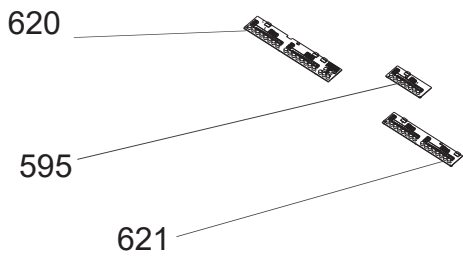

620

595

621

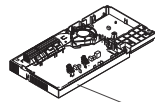

543M

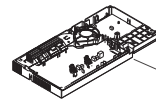

543S



514

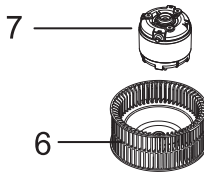

7

6

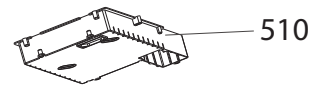

510