

240

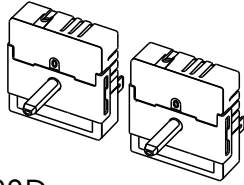

242



222D

222S

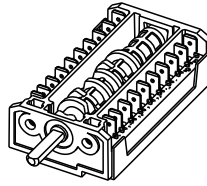

226

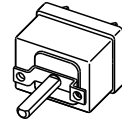

230

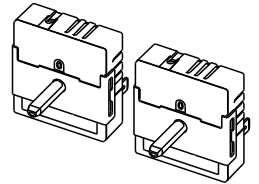

222D

222S

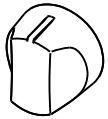
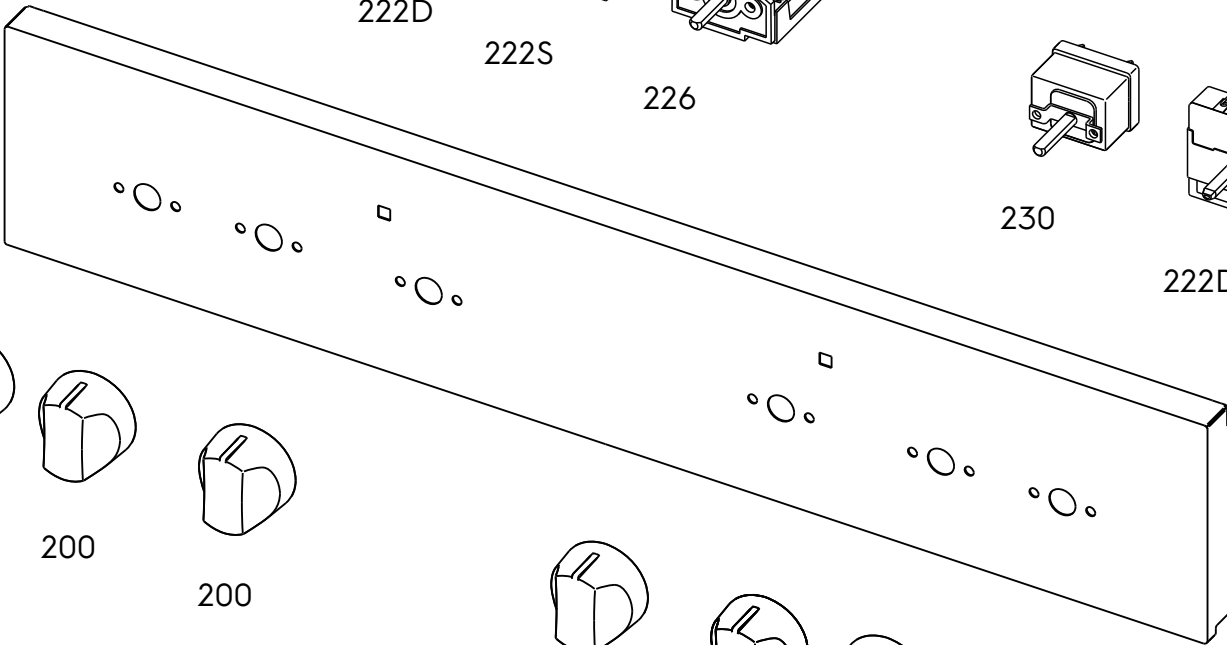

200

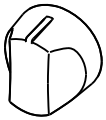

200



200



200

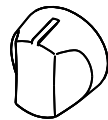

200



200

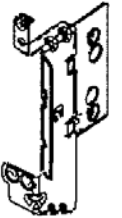

212A

210