

210

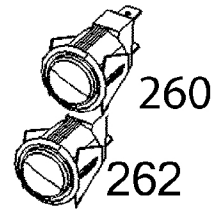

220

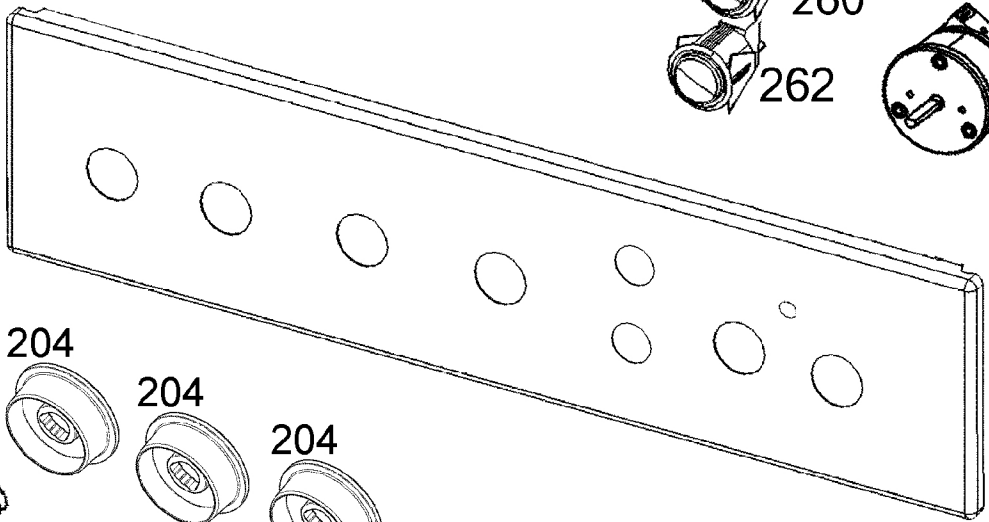

204



204

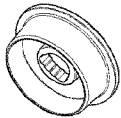

204

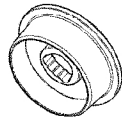

204



206



206



206



200

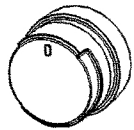

200

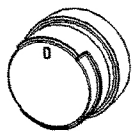

200

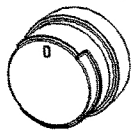

200

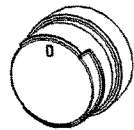

204C



206



200C

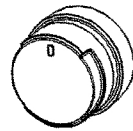

200F

