

240

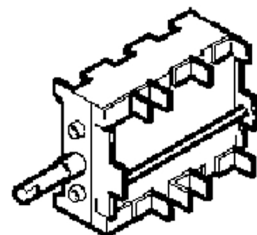

242



226



220

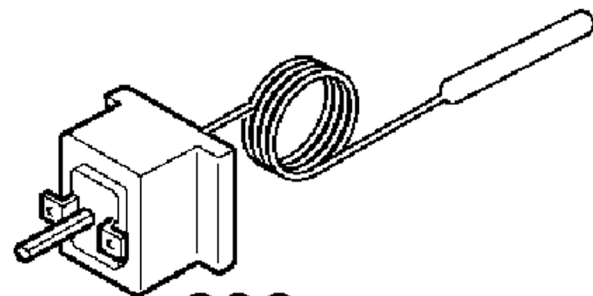

230

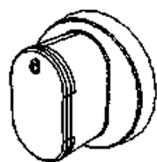

200

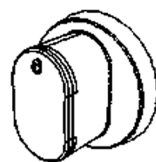

200

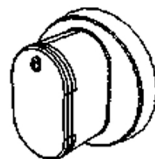

200

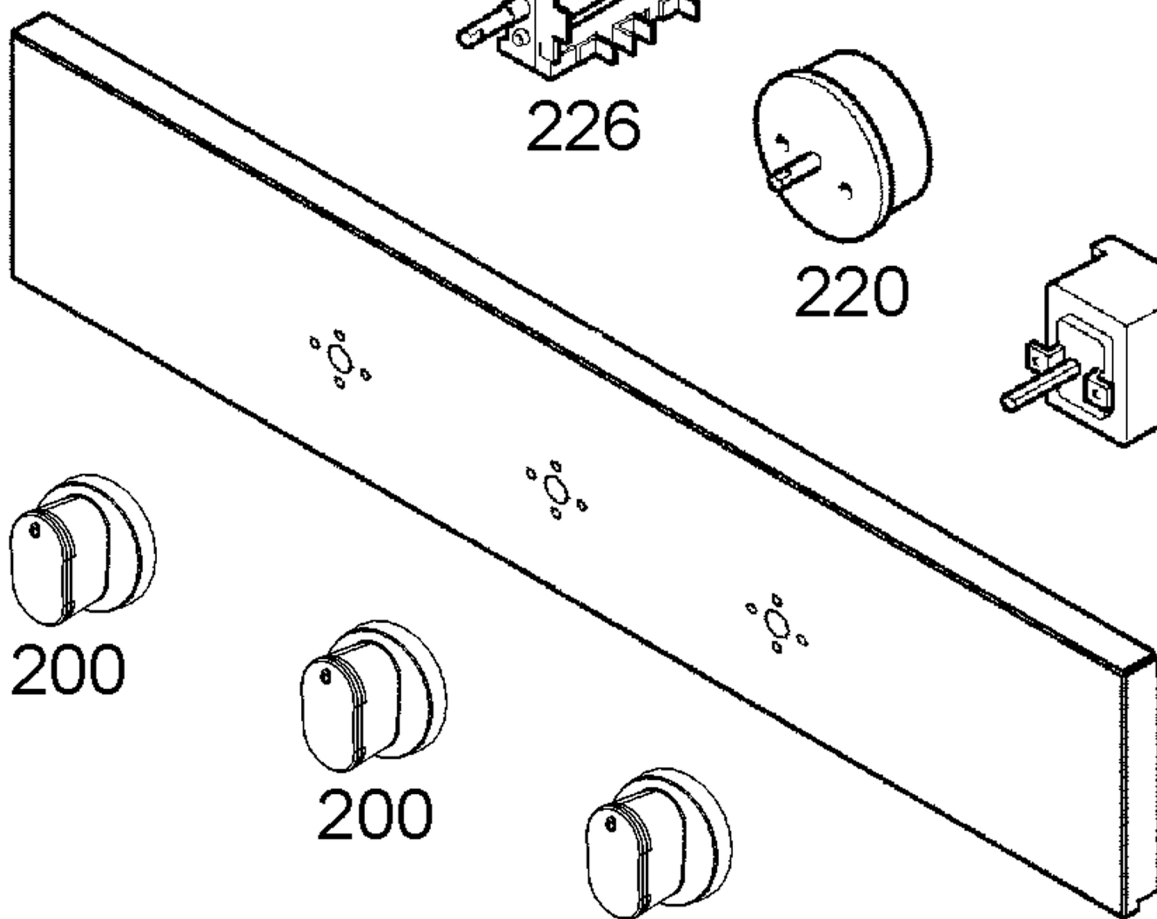

210