

510V



522



518V

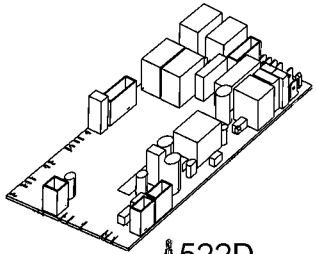

516A

522D



502U



540T



504U



506U



518

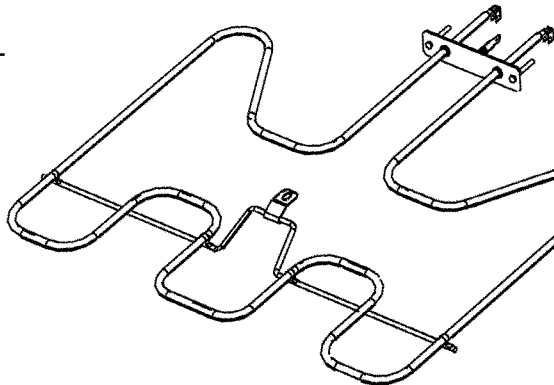

500U

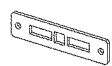

540B



540A



510C

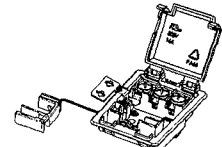

530A

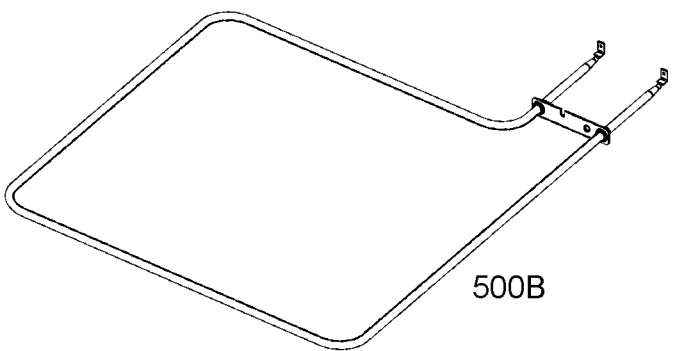

500B



500C



542C

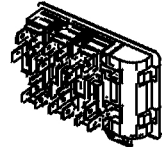

530

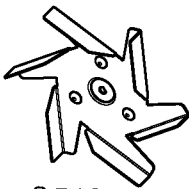

512

Ø513

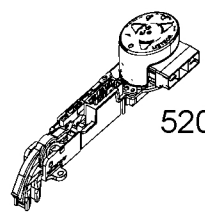

520