

510V



522



518V

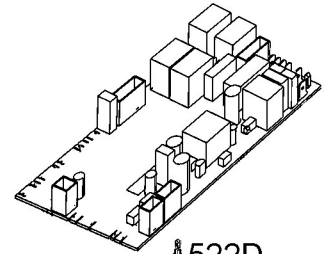

516A

522D



502U



504U



506U



518

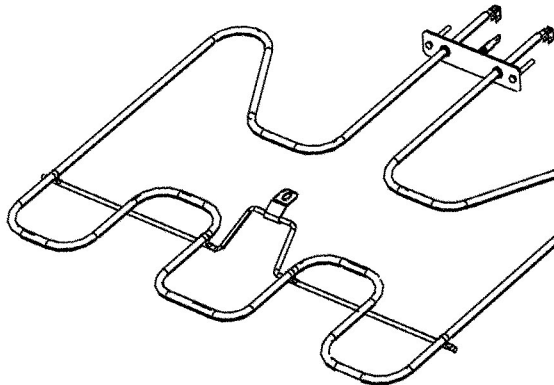

500U

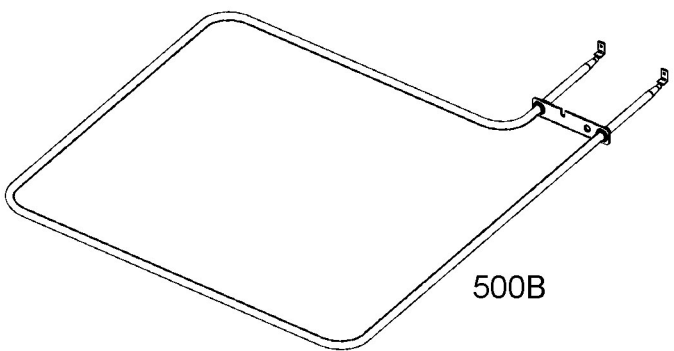

500B



510C

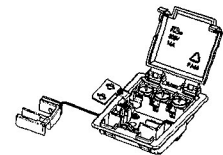

530A

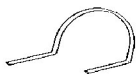

542C

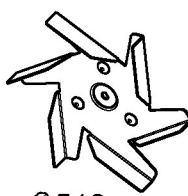

512

513

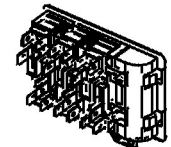

530

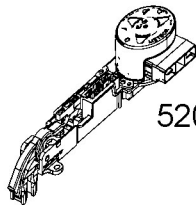

520