

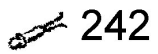

240

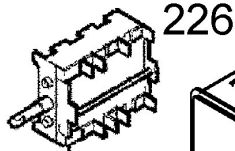

242



226

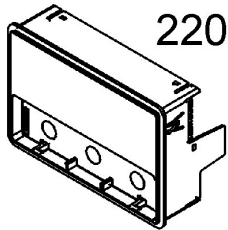

220

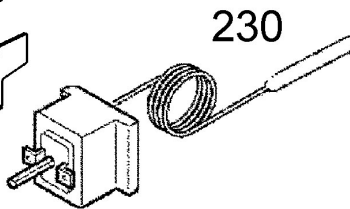

230

210

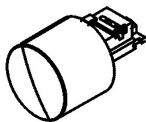
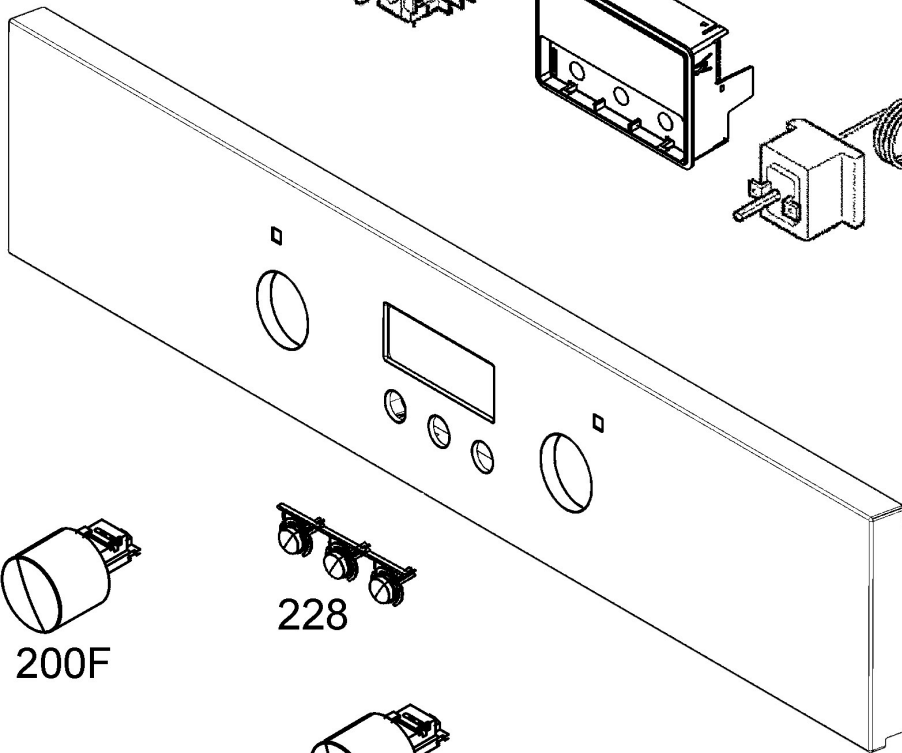

200F



228

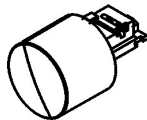

200T



212A