

340

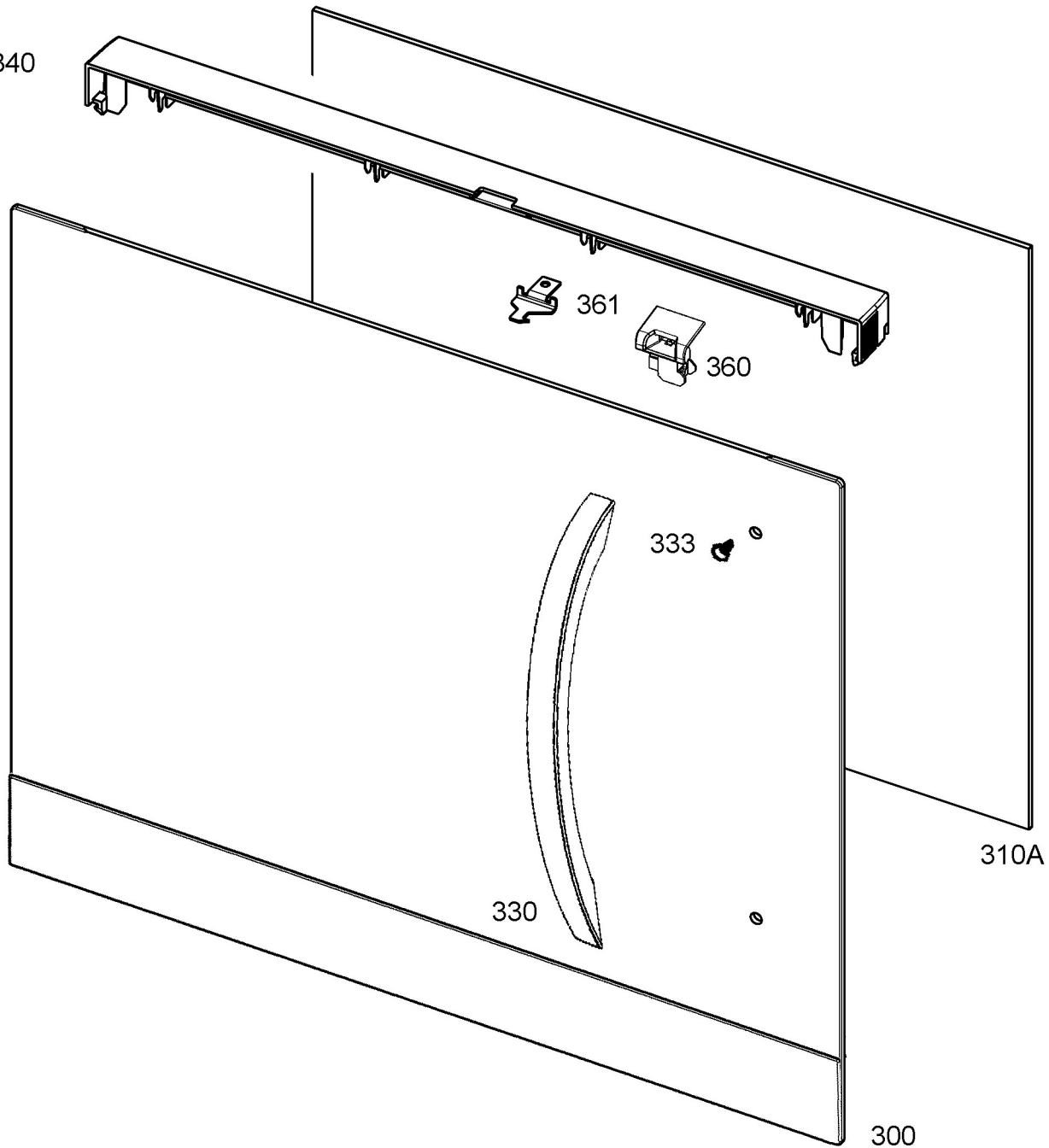

361

360

333

330

310A

300