

522A

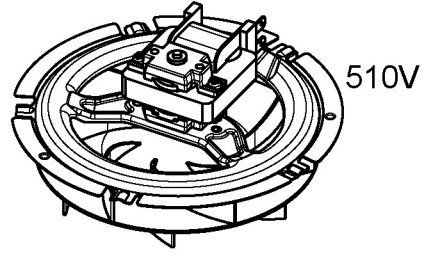

518A

522

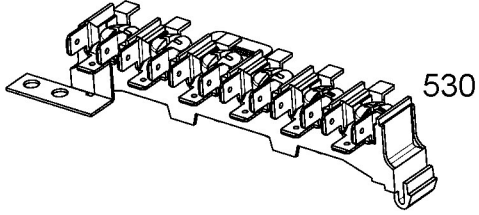

534

540U

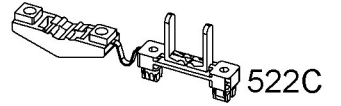

502



504



506

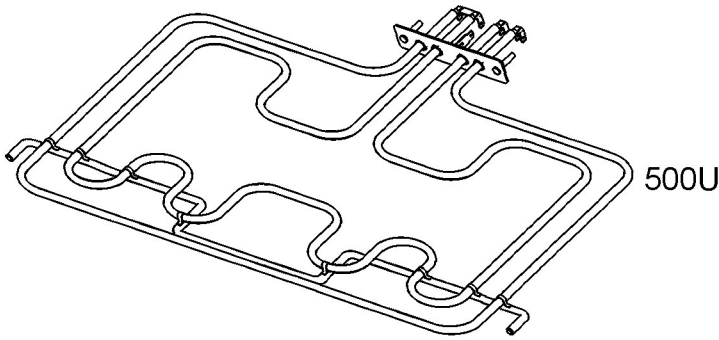

500U

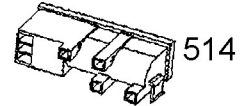

514

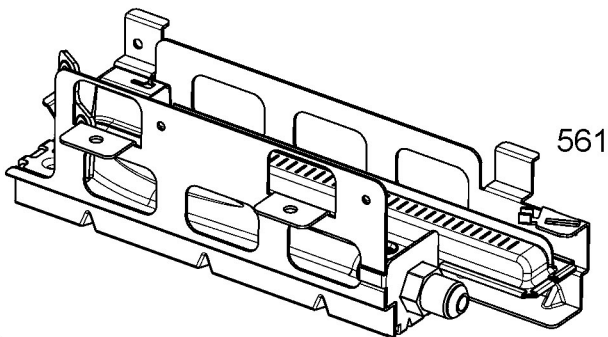

561



542



592

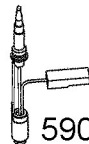

590A