

510V



522



518V

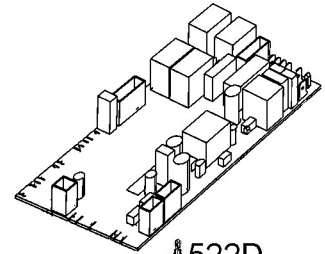

516A

522D



502U



504U



506U



518

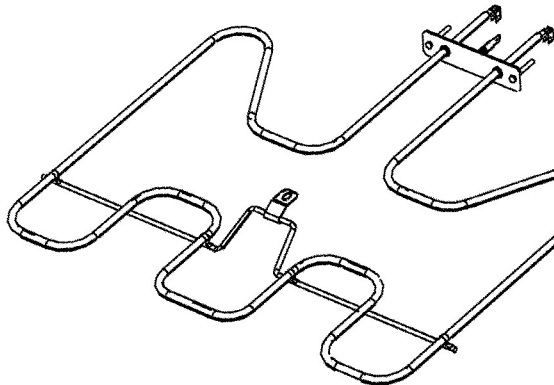

500U

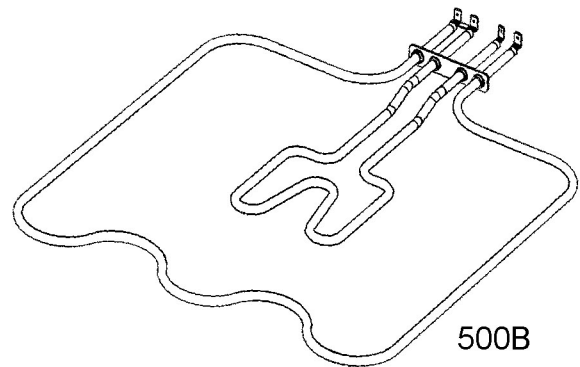

500B

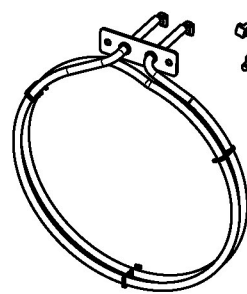

500C



510C

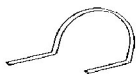

542C

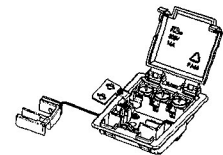

530A

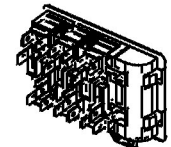

530

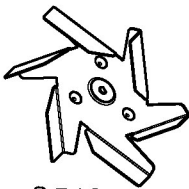

512

Ø513

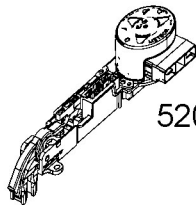

520