

240

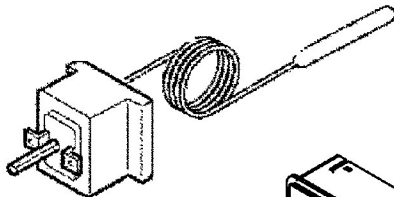

242



230

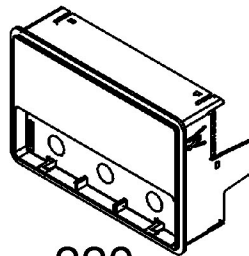

220

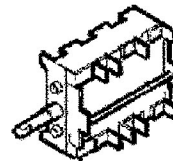

226

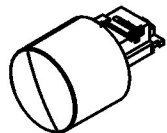

200T



228

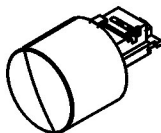

200F

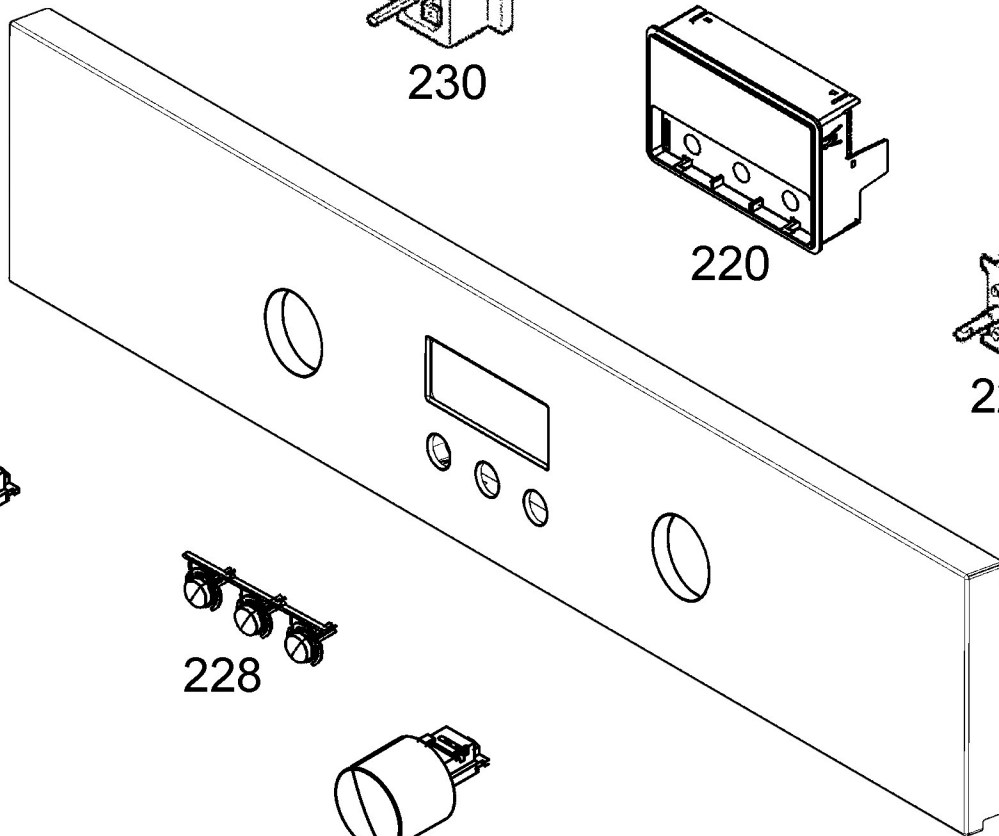

210

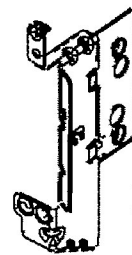

212A