

193

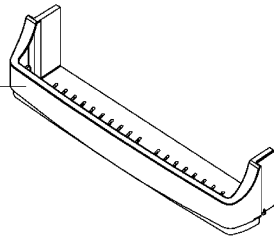

151



11



153



180



154



194



195

196



OPTIONAL

175

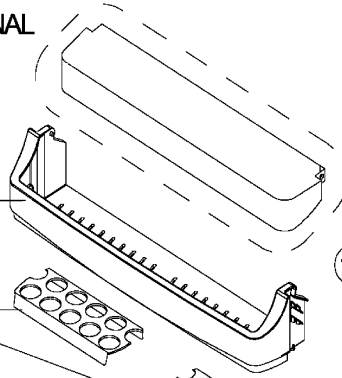

159

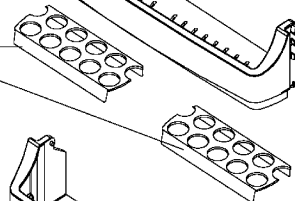

151



11

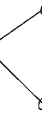

152



194



195

196



OPTIONAL

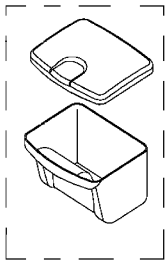

175

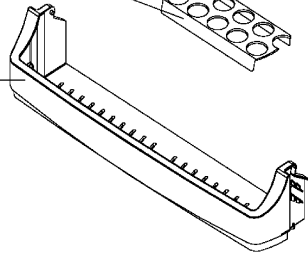

155



OPTIONAL

177

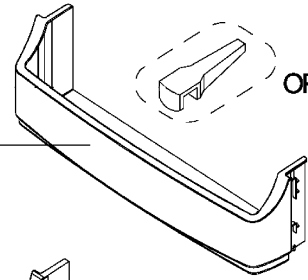

174



151



7



188

