

30 31

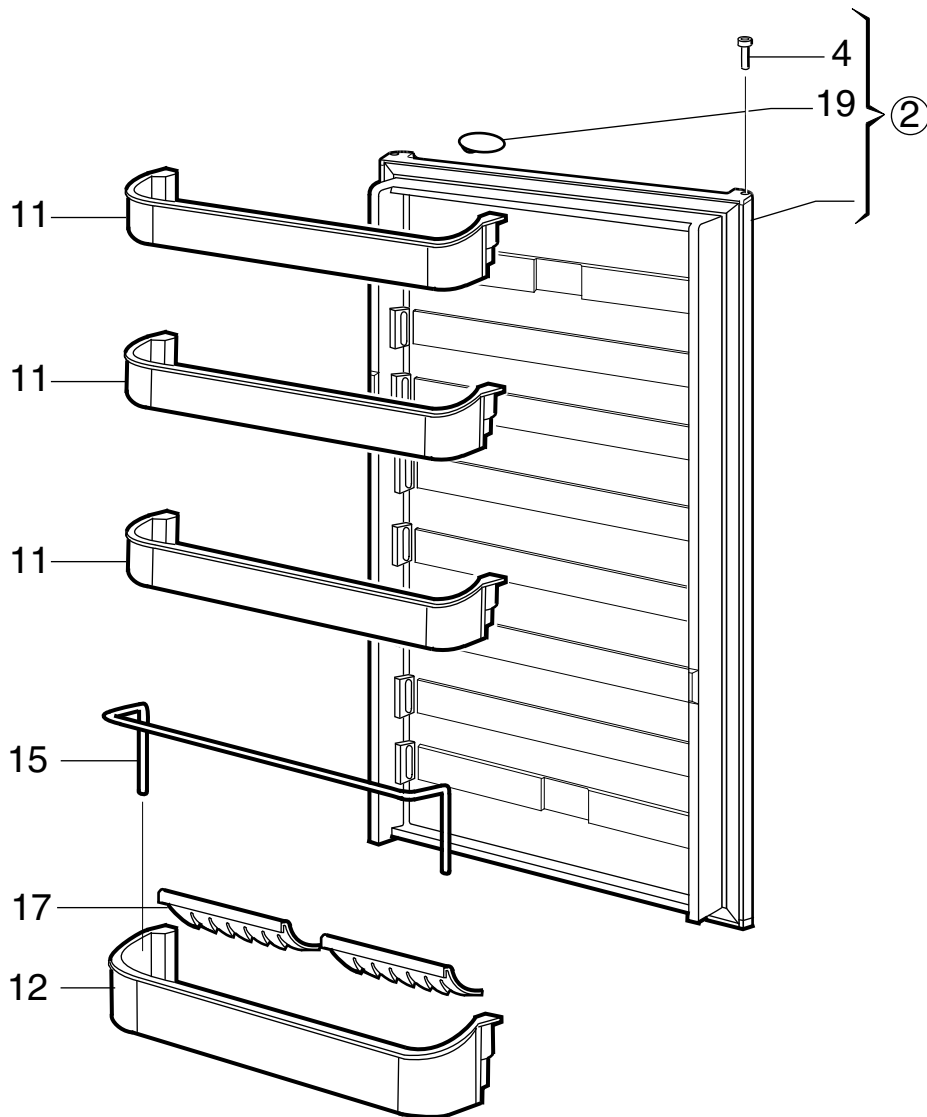

NCMOA2092447