

# CAPPE BASSE BLDC D2

58

86

56

CAS

IME

998

AIE

60

76

343

362

AMF

474

472

AQI

9

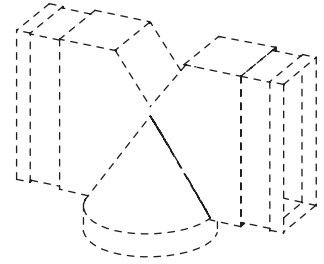
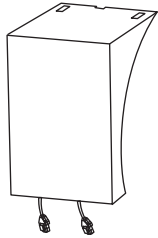
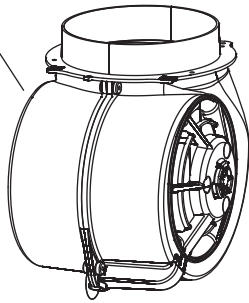
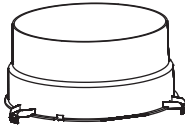
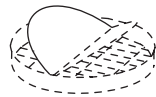
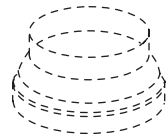

122



120

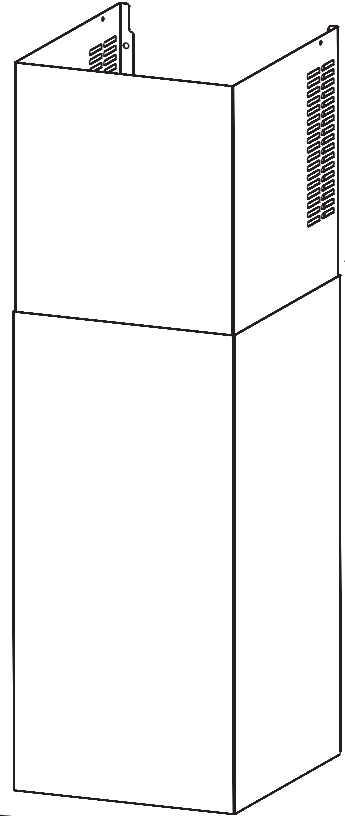

485

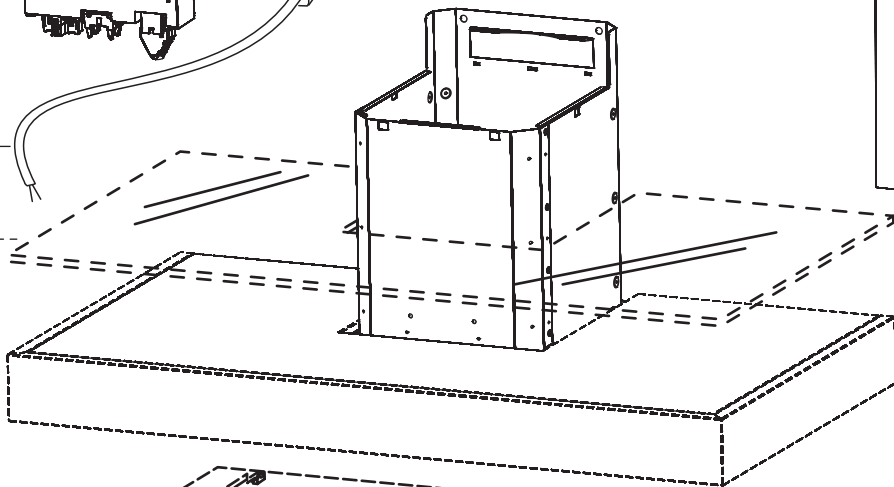
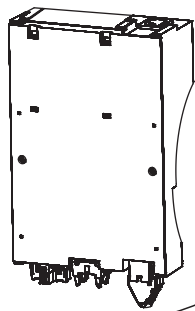

113

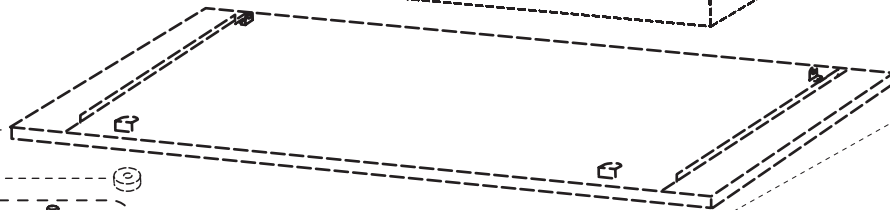

67

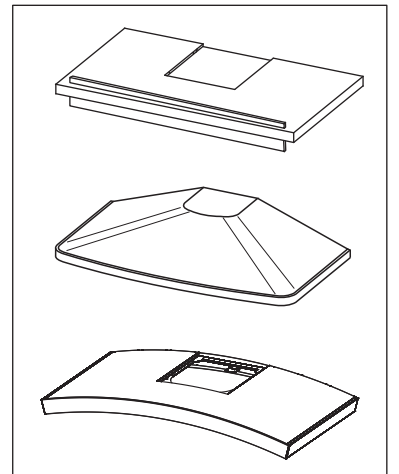
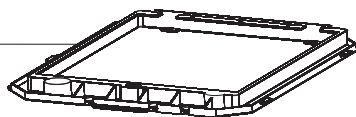
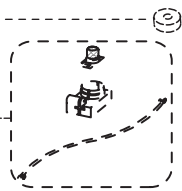

508

