

SPHERA P-B

SAA

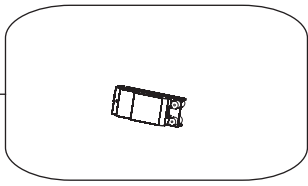

IME

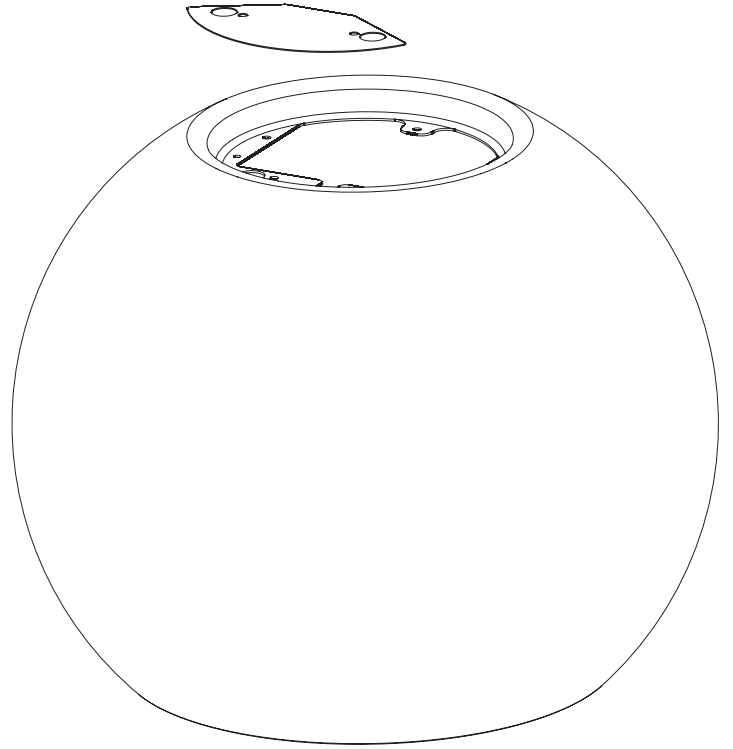
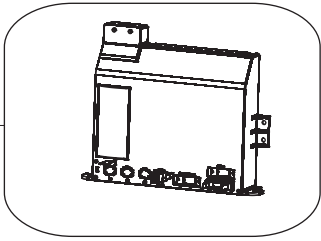

119

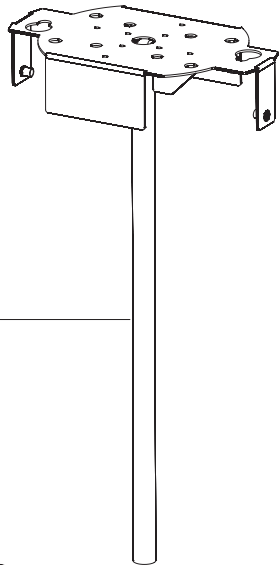

332

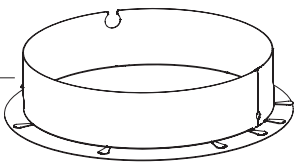

118

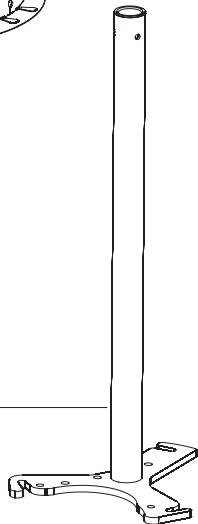

CAS

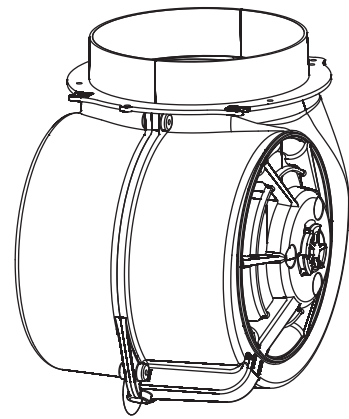

1

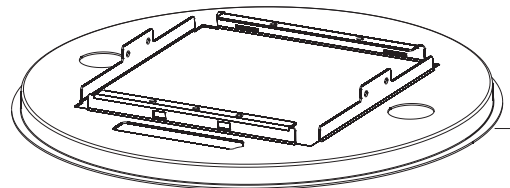

508



AQI



199



67

26

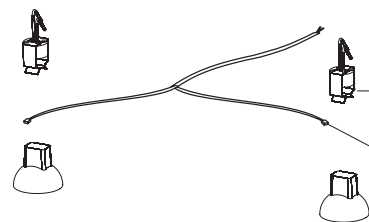

9

