

122

86(03292210)

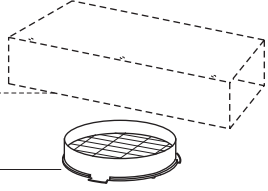

58

(08088362)86

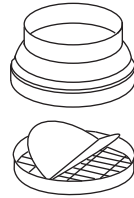

IME

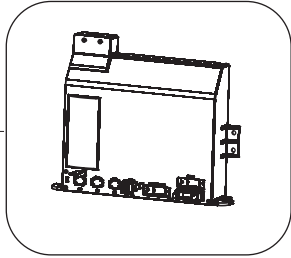

60

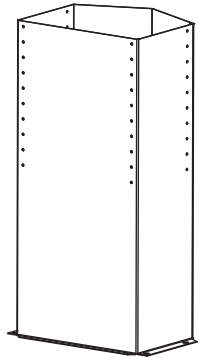
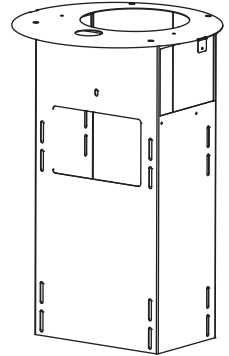
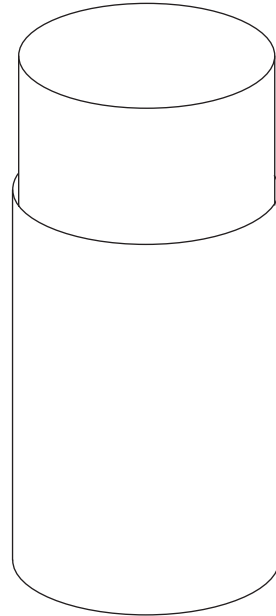
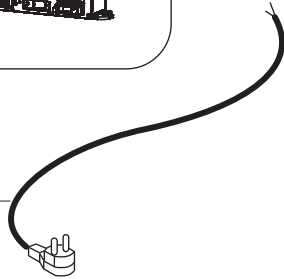

119

118

CAS

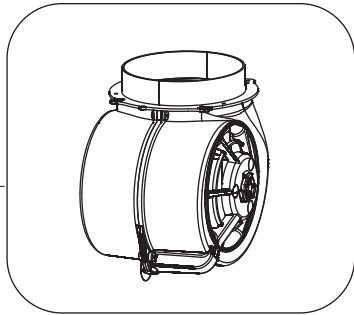

AQI

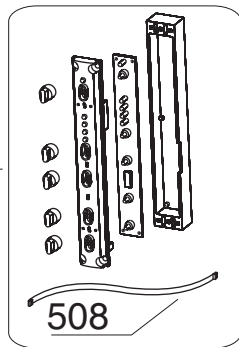

508

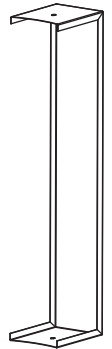
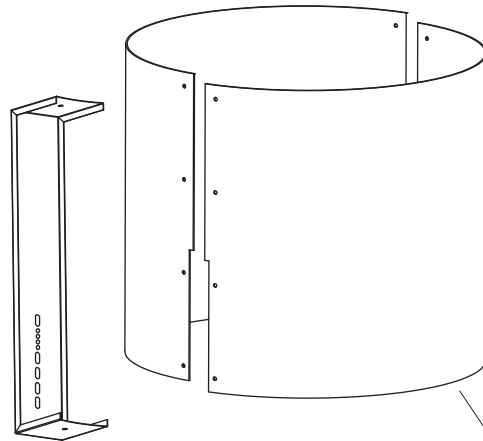

343

96

342

252

5

AMF

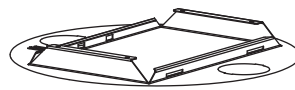
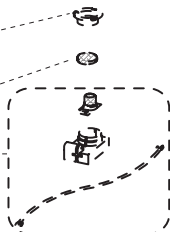

1



67

474

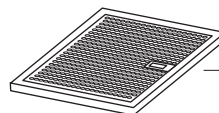

9