

ALA

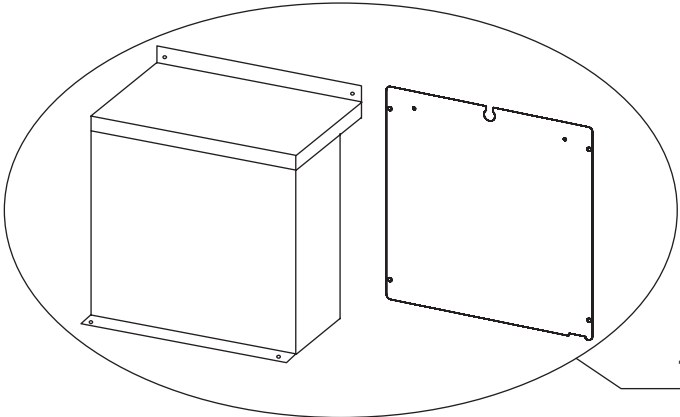

122

60

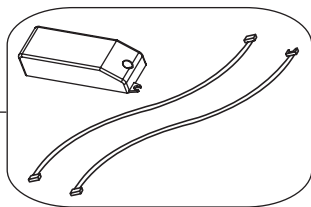
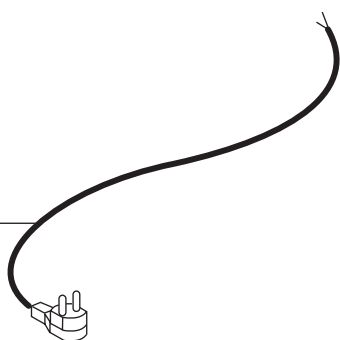

86

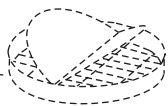

CAS

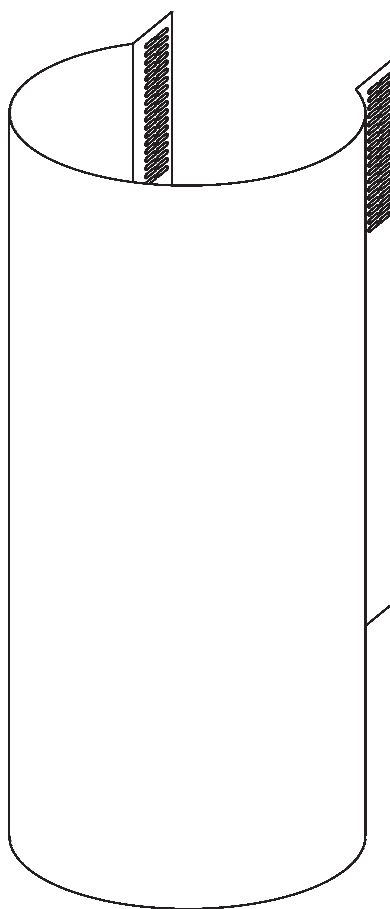
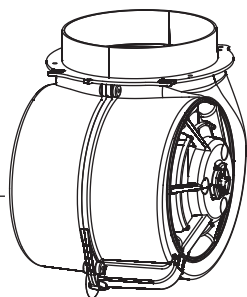

118

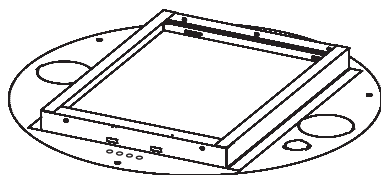

1

AQI

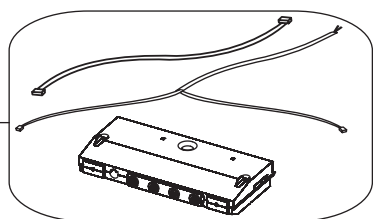

223

0000



474

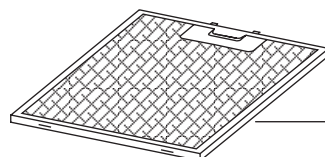

9