

K9388 P-A / K9388 ASC P-A

58



86



56

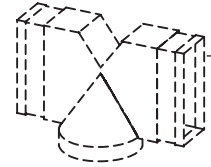
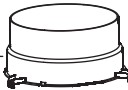

122

CAS

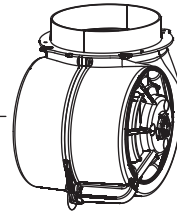

120

998



IME

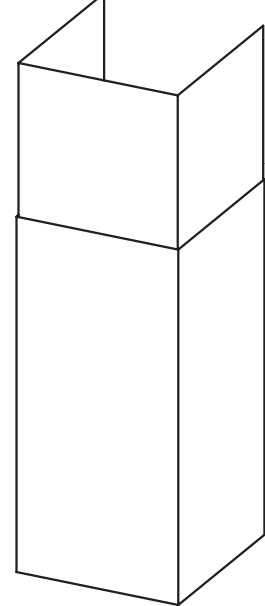
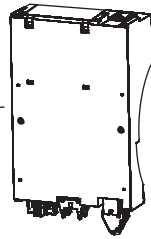

485

60

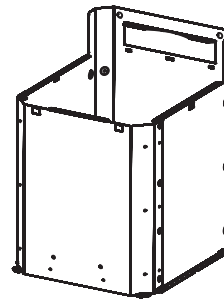

76

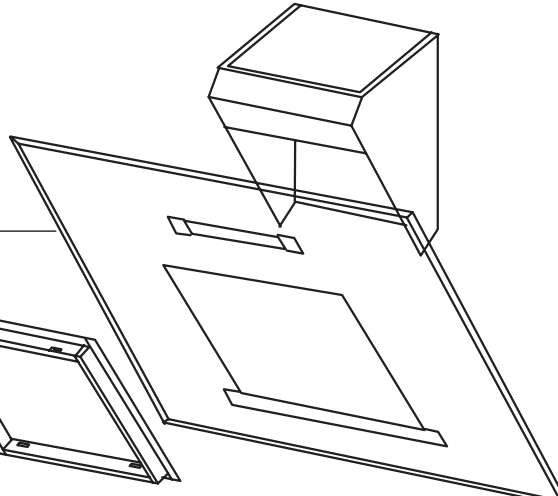

1

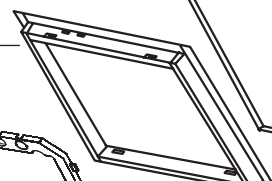

472

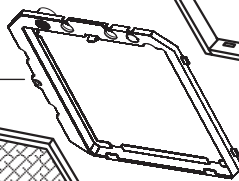

9

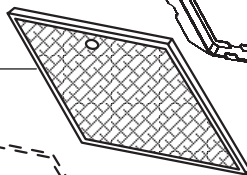

252

5

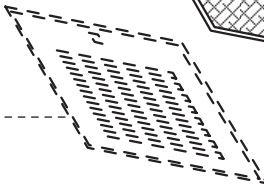

(08087198) 5

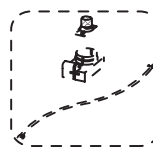

AMF

AQI

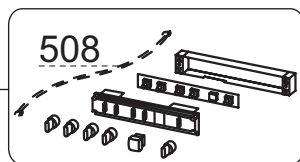

92

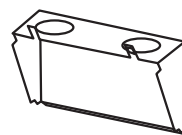

67

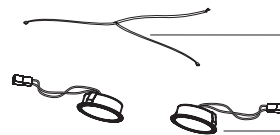

474