

IME

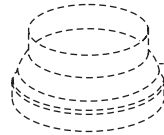

58

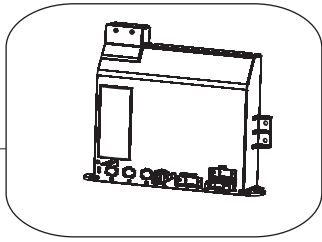
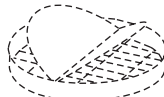

86

60

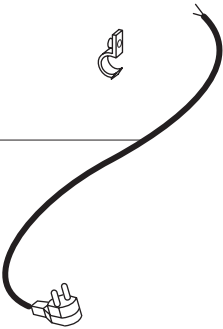

CAS

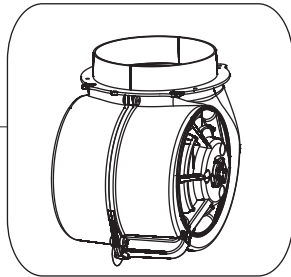

252

5

AMF

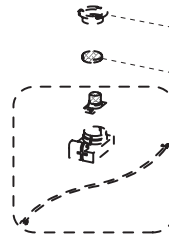

AQI

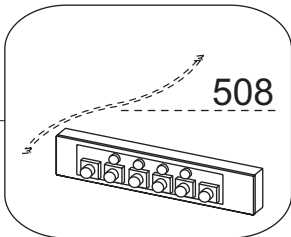

508

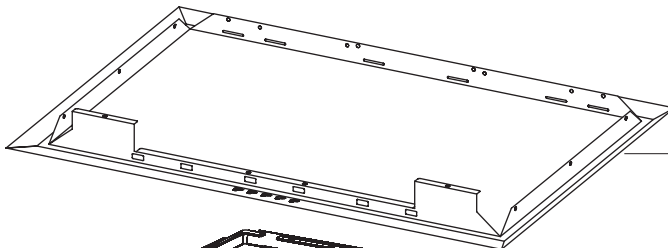

1

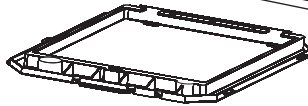

472

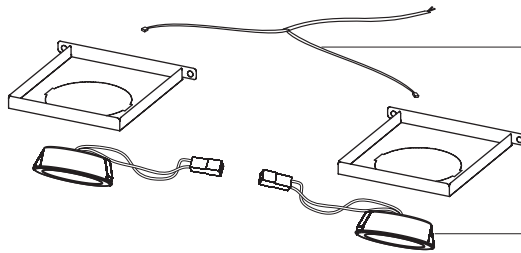

67

474

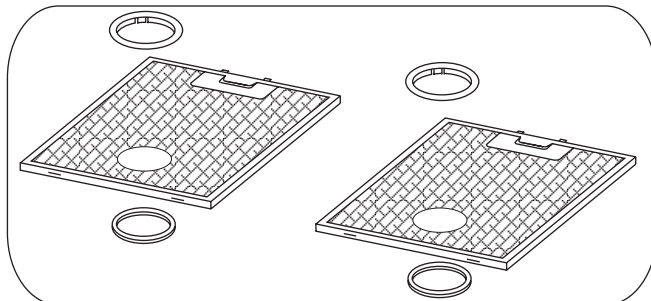

9