



Electrolux

SERVICE MANUAL

Refrigeration

REFRIGERATOR

FS TT

ZRG11600WA

ERT1100AOW



Document Revisions

Rev.	Date	Description	Author
00	03/2020	Document creation	Anna Grimlund

EN

Publication number

599 83 61-27

Edition: 03/2020 - Rev. 00

FOR INTERNAL AND PARTNERS USE ONLY

© ELECTROLUX HOME PRODUCTS

Consumer Service - EMEA

Quality & Continuous Improvement - Technical Support

Contents

Warnings and precautions for safety.....	3
Parts Description.....	3
Circuit diagram	4
Cooling diagram	4
Checking the Thermostat.....	5
Checking the Compressor.....	6
The guide for Disassembly Common parts of Refrigerator.....	7
◆ The instruction of replacing thermostat.....	8
◆ The instruction of replacing lamp.....	8
◆ The instruction of replacing Door switch	9
◆ The instruction of replacing PTC Starting relay and Overload protector	9
Troubleshooting	10
◆ The common problem judging method.....	10
◆ The solution for the common problem.....	11
Note:	14

Warnings and precautions for safety

Please observe the following safety precautions in order to use safely and correctly the refrigerator and to prevent accident and danger during repair.

1. Be care of an electric shock. Disconnect power cord from wall outlet and wait for more than three minutes before replacing PCB parts.

Shut off the power whenever replacing and repairing electric components.

2. When connecting power cord, please wait for more than five minutes after power cord was disconnected from the wall outlet.

3. Please check if the power plug is pressed down by the refrigerator against the wall.

If the power plug was damaged, it may cause fire or electric shock.

4. If the wall outlet is over loaded, it may cause fire.

Please use its own individual electrical outlet for the refrigerator.

5. Please make sure the outlet is properly earthed, particularly in wet or damp area.

6. Use standard electrical components when replacing them.

7. Make sure the hook is correctly engaged.

Remove dust and foreign materials from the housing and connecting parts.

8. Do not fray, damage, machine, heavily bend, pull out or twist the power cord.

9. Please check the evidence of moisture intrusion in the electrical components.

Replace the parts or mask it with insulation tapes if moisture intrusion was confirmed.

10. Do not touch the icemaker with hands or tools to confirm the operation of geared motor.

11. Do not let the customers repair, disassemble and reconstruct the refrigerator for themselves.

It may cause accident, electric shock, or fire.

12. Do not store flammable materials such as ether, benzene, alcohol, chemicals, gas, or medicine in the refrigerator.

13. Do not put flower vase, cup, cosmetics, chemicals, etc., or container with full of water on the top of the refrigerator.

14. Do not put glass bottles with full of water into the freezer.

The contents shall freeze and break the glass bottles.

15. When you scrap the refrigerator, please disconnect the door gasket first and scrap it

Parts Description

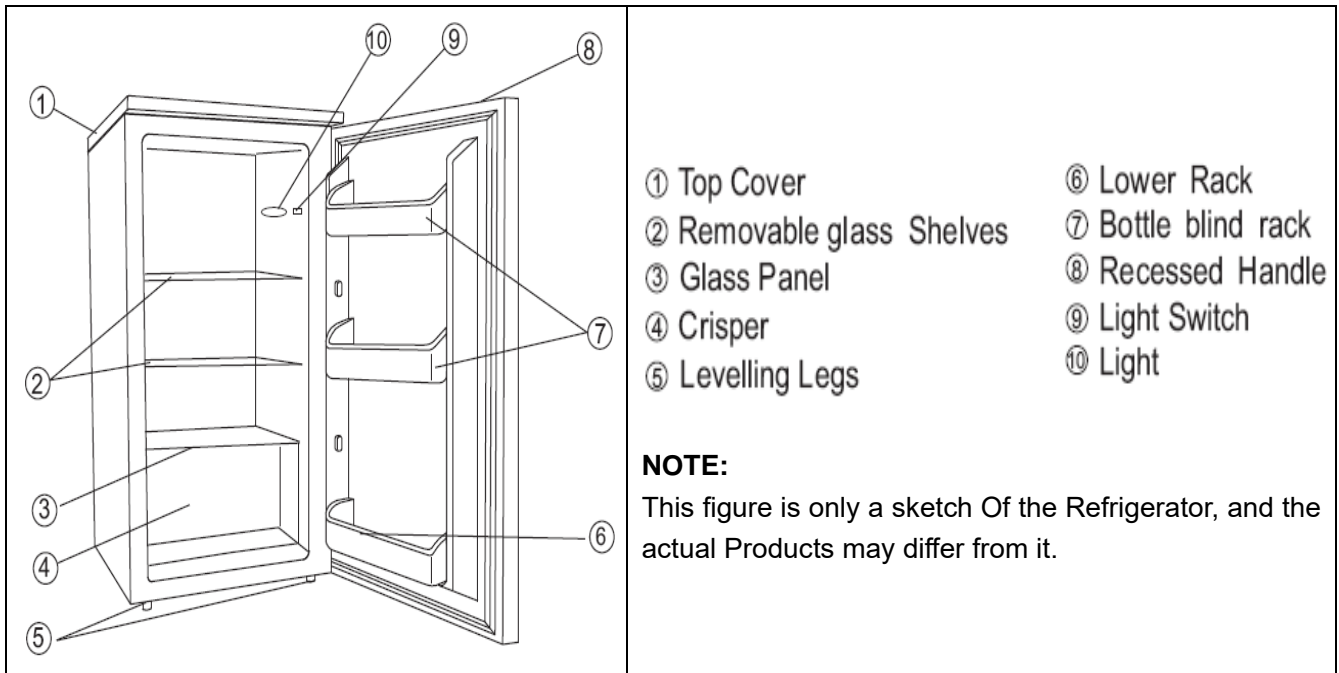

Circuit diagram

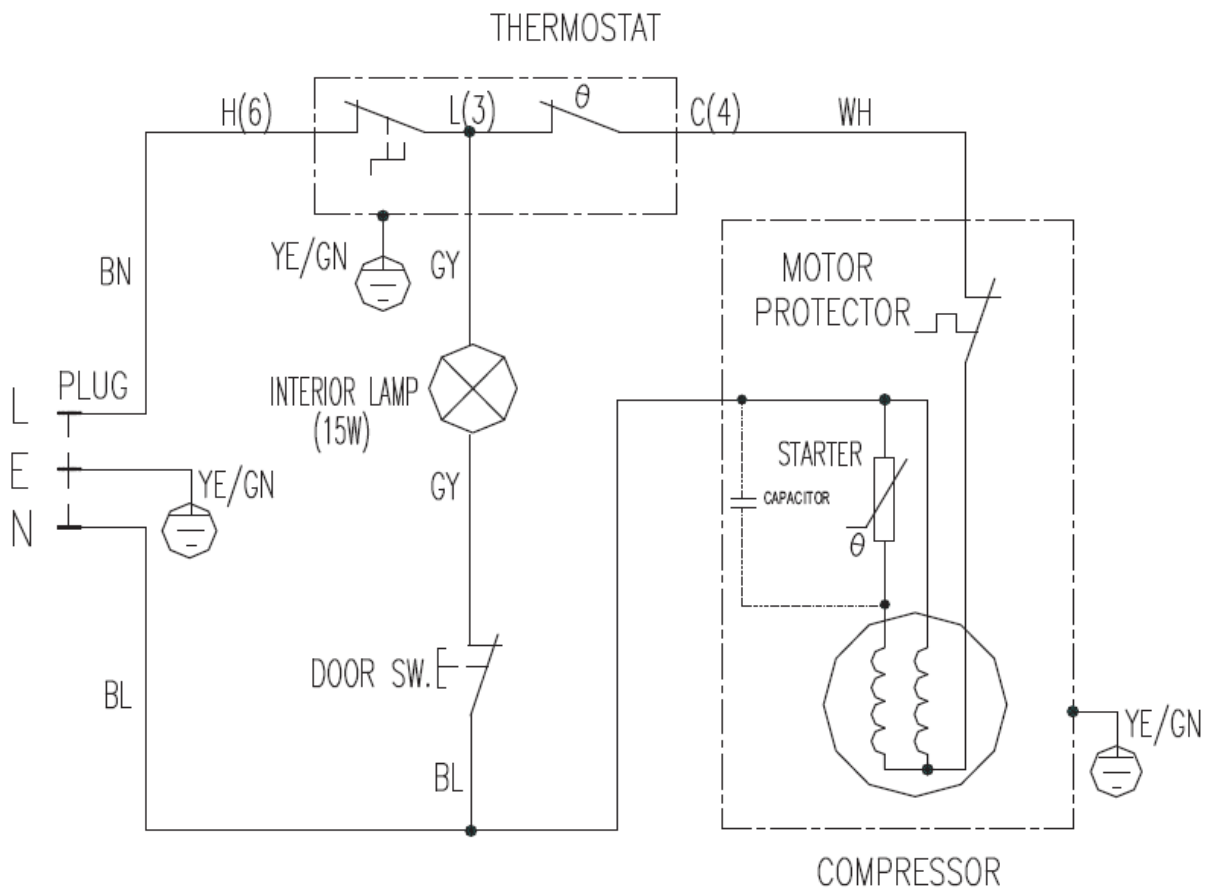

Cooling diagram

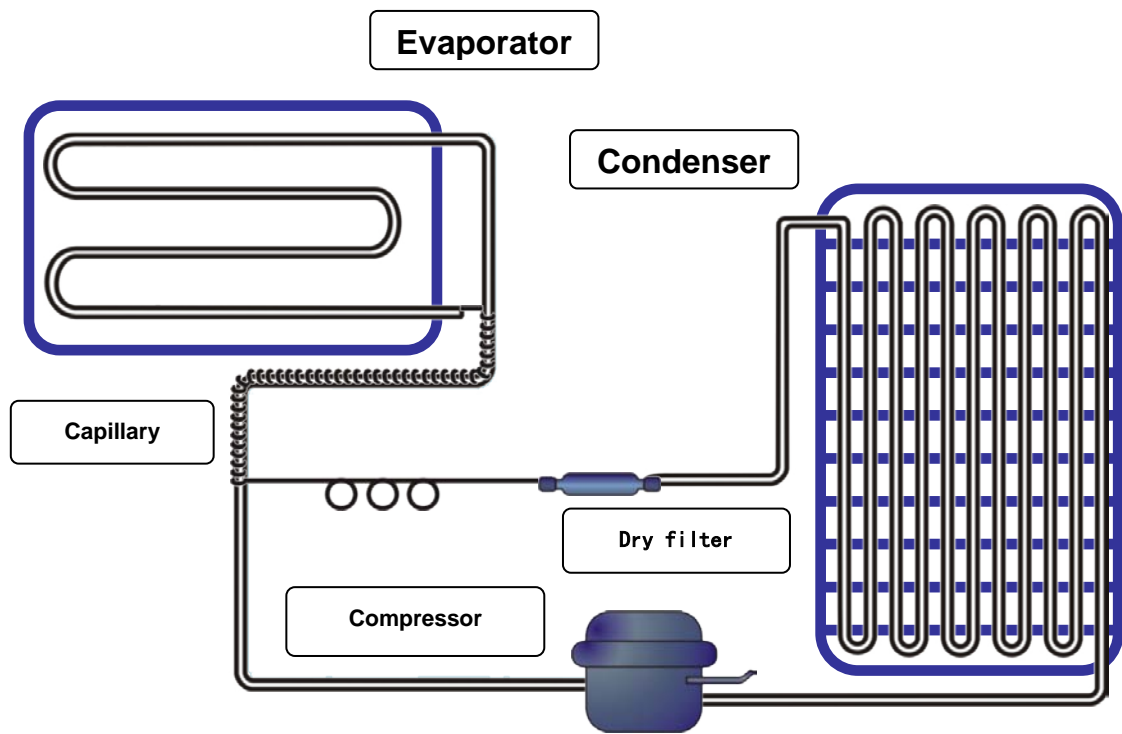

Checking the Thermostat

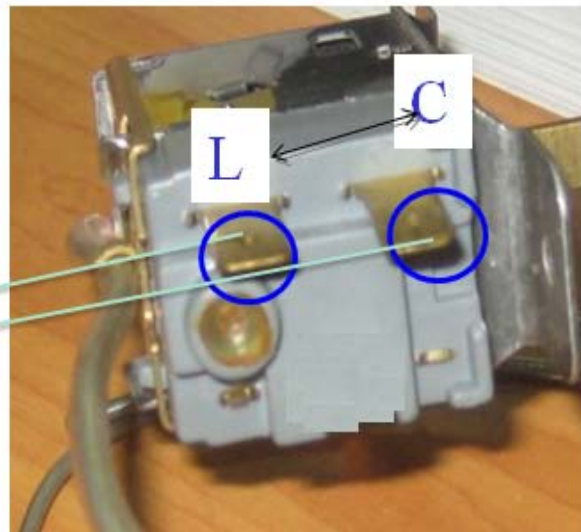
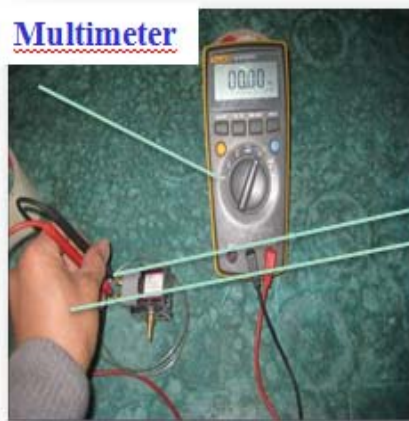

Use a multi-meter to test the resistance between L & C when the thermostat is at normal position such as: “ 1, 2, .. 6” :

If there shows “000” then the thermostat is OK

If there shows anything but “000” then the thermostat is always at OFF Position and compressor will not start ever.

Put the sensor pipe of the thermostat in the freezer compartment like the below pic shows.

Put the thermostat at Max 6 position and let it keep this position for 20 minutes.

Turn the knob from 6 to 1 slowly

If you can feel a stop signal like kind of noise of “da” the thermostat is ok.

If there is no stop signal then the thermostat is always at ON position and the compressor will keep on working and will not stop.

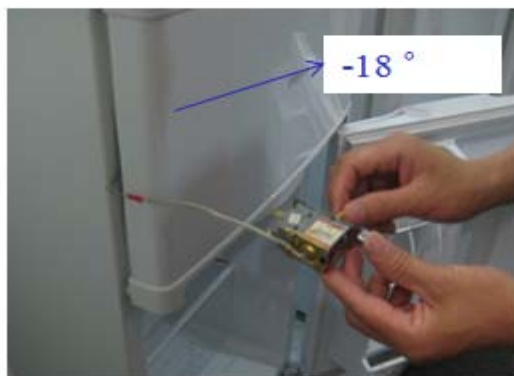

Checking the Compressor

Use a multi-meter to test the resistance between C & S, M&S and M&C :

Normal range of C&S : About 5-20 Ω

Normal range of M&S : About 5-20 Ω

Normal range of M&C : About 10-40 Ω

If the test result is not in this range then it means the inner coil has some problem and the compressor can not work properly.

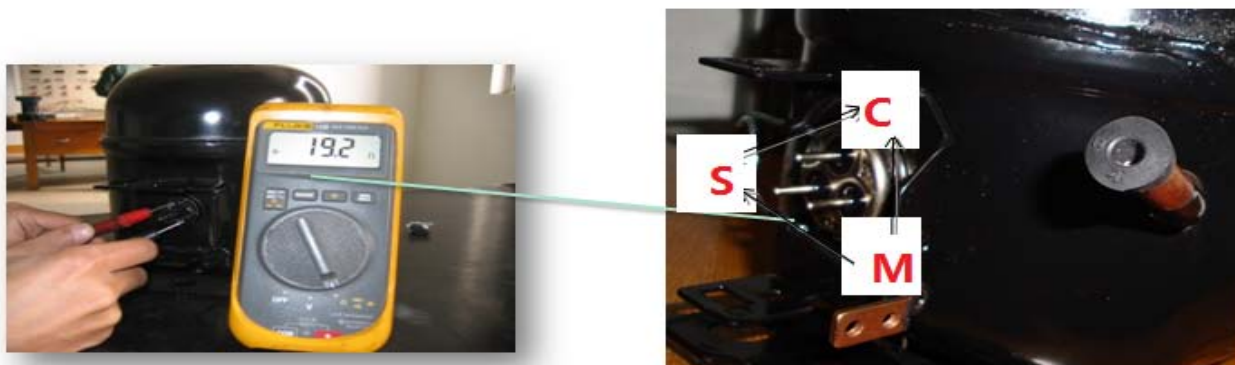

Compressor Protector test —

Use a multi-meter to test the resistance between the two end as the pic show :

If there show 000 or almost 0 then it is OK.

If there is no response then it is broken.

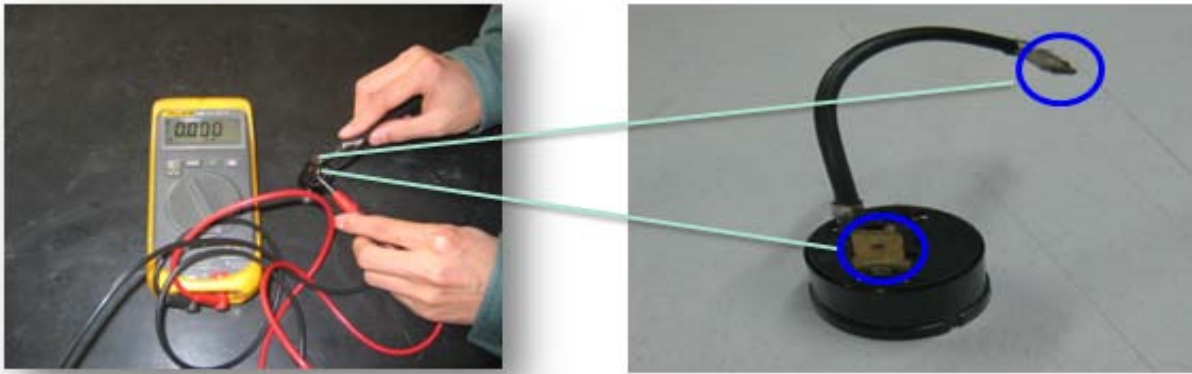

Compressor PTC starter test —

Use a multi-meter to test the resistance between the two end as the pic show :





If there show the number is between About 9-25 Ω then it is OK.

If there show 000 or no response then it is broken.

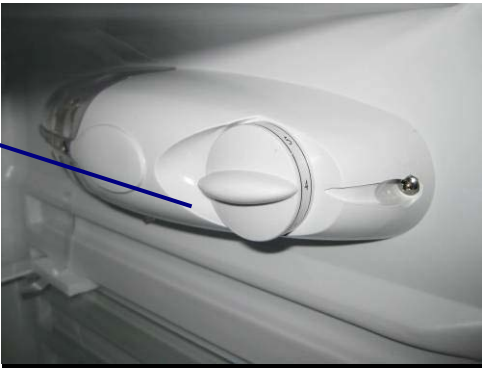

The guide for Disassembly Common parts of Refrigerator

◆ The instruction of replacing thermostat

<p>The location of the thermostat</p>		
<p>Remove screws of thermostat box</p>		
<p>Unplug the connecting wire Take out the thermostat</p>		

◆ The instruction of replacing lamp

<p>The location of the lamp The operation of replacing lamp is same to remove thermostat</p>		
--	---	--

- 1、 Remove the lamp cover
- 2、 Take out the lamp



◆ The instruction of replacing Door switch

The location of door switch



Take out the door switch with a screwdriver



◆ The instruction of replacing PTC Starting relay and Overload protector

Take down Spring tap and Cover.



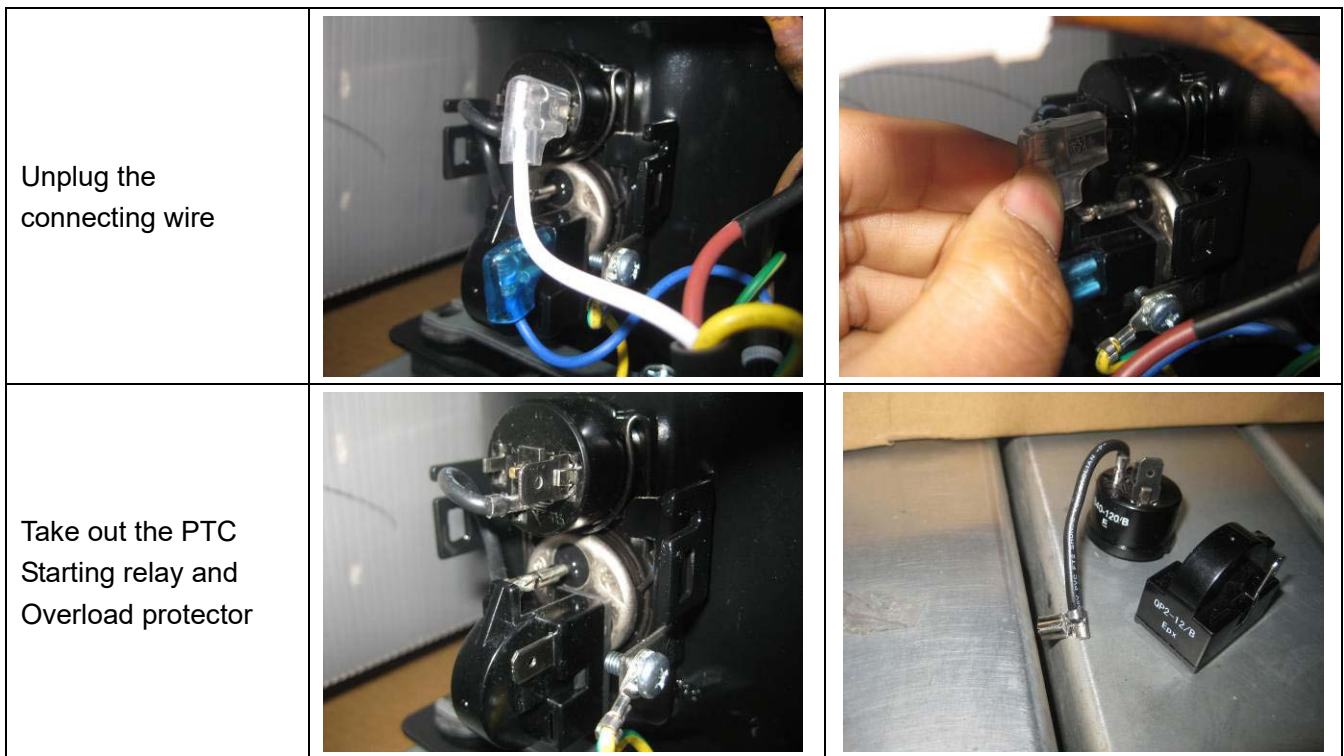

Troubleshooting

◆ The common problem judging method

Problem	Cause
Refrigerator can't start	1.1 Is the power cord connecting well? 1.2 Is the power voltage too low? 1.3 Is the ambient temperature too low? 1.4 Is the circuit on power? 1.5 Is there some default in compressor 1.6 Is the refrigeration system blocked by ice or dirty, please stop the unit and restart after 10 minutes to see if the compressor can start.
Weak cooling effects	2.1 Is there any heat source around the refrigerator? 2.2 Is there enough space around the refrigerator for rejection of heat? 2.3 Is the setting of the temperature appropriate? 2.4 Is there too much food or overheating food in it? 2.5 Does the door open frequently? 2.6 Is the door completely closed? 2.7 Does the gasket destroyed or distort? 2.8 Does the gas leak?
The unit can not stop running	3.1 Is there any heat source around the refrigerator? 3.2 Is there enough space around the refrigerator for rejection of heat? 3.3 Is the setting of the temperature appropriate? 3.4 Is there too much food or overheating food in it? 3.5 Does the door open frequently? 3.6 Is the door completely closed? 3.7 Does the gasket destroyed or distort?

	3.8 Is the thermostat good operation? 3.9 Does the gas leak?
Ice up in the freezing chamber	4.1 Is the setting of the temperature appropriate? 4.2 Is there multi-moisture food and too close to the back wall of the refrigerator? 4.3 Is the ambient temperature too low? 4.4 Is the electric parts on good condition, specially the thermostat wich will cause the unit non-stopping
Abnormal noise	5.1 Is the refrigerator stably placed? 5.2 Does the refrigerator bump other objects? 5.3 Whether the internal accessory of the refrigerator is in the right place. 5.4 Whether the water plate of compressor is fall from the unit. 5.5 Does the tube of the refrigeration system bump each other? 5.6 The noise sound likes Water flow inside the refrigerator, in fact,it is normal, which is caused both when refrigerator start and shut-down; in addition, frost-dissolving causes this sound, too, which is a normal phenomenon. 5.7 There will be a cracking sound in the cabinet ,when the cabinet or cabinet accessory contracting or expanding, this sound will be made, which is normal. 5.8 The motor operation sound in the compressor is appears to be louder at night or begin starting. which is a normal phenomenon; also the uneven placing would lead to too much running noise.
There is a peculiar smell in the units	6.1 Is the food with special smell sealed tight? 6.2 Does it have long time storing food or degenerated food? 6.3 Whether the internal cabinet needs cleaning.
the forefront or the middle cabinet heats	7.1 As fridge Anti-condensation tube is placed here and caused the above phenomenon, which is normal.
Refrigerator's two sides or the back heat	8.1 As condensation tube is placed here and caused the above phenomenon, which is normal.
the cabinet surface condensation	9.1 Air humidity is too large.

◆ The solution for the common problem

1.Cooling is not enough good (Many reasons might cause that cooling not enough good, as blow :)		
Reason	analysis	Solutions
1) Leakage of Gas	If some gas leaked unit will work not well. Phenomenon of failure: a. lower pressure of liquid cycle system b. high temperature of copper tube of discharging gas, hand feels very hot. C. much noise, sounds like "ZZZZZ", comes from outlet of capillary. d. the temperature fell down very slowly.	First find out the point of leaking on tube, and then sealed it, vacuuming it, finally recharge with Gas. Note: If you find oil on somewhere, it is possible that leakage point is there.
2) The quantity of Gas is too much	If too much Gas was charged into the cycle system, the extra gas will occupy some	First stop unit for several minutes, and then open charging tube,

	<p>space of evaporator, so that the area of heat exchange becomes less, unit will work not well.</p> <p>Phenomenon of failure:</p> <p>a, higher pressure of liquid cycle system than norm.</p> <p>b, higher temperature of condenser.</p> <p>c, larger electric current of compressor</p> <p>d, there maybe ice on the suction tube.</p> <p>e, when gas is too much, some gas liquid might goes back into compressor, compressor will be damaged by liquid.</p>	<p>discharge all of gas. Change a new filter, and then recharge gas, finally sealed the system.</p>
<p>3) There is air in the liquid cycle system</p>	<p>The air in system will cause lower efficiency of cooling.</p> <p>Phenomenon of failure:</p> <p>a, higher pressure of liquid cycle system than norm, but the pressure is not over the limit.</p> <p>b, higher temperature of discharging tube.</p> <p>C, much noise</p>	<p>First stop unit for several minutes, and then open charging tube, discharge all of gas. Change a new filter, and then recharge gas, finally sealed the system.</p>
<p>4)Low working efficiency of compressor</p>	<p>General when a compressor works for many years, some parts of compressor were wear, so that compressor discharge less gas out, unit does not work strongly.</p> <p>Phenomenon of failure:</p> <p>a, lower pressure of discharging, check the pressure of system with pressure meter to see if it is normal.</p> <p>b, higher temperature of compressor surface.</p> <p>C, cut off the discharging tube, to see if you can block the gas coming out of the tube when compressor is working.</p>	<p>Change a new compressor.</p>
<p>5) There is something that blocked the liquid cycle system</p>	<p>Some time there is something blocked the filter of liquid cycle system, so that unit is not cold.</p> <p>Phenomenon of failure:</p> <p>a, lower pressure of discharging</p> <p>b, lower temperature of discharging.</p>	<p>Change a new filter</p>
<p>2.NO COOL (Popular failure reasons are below):</p>		
Reason	analysis	Solutions:
<p>1) Leakage of gas</p>	<p>Phenomenon of failure:</p> <p>a, leaking fast</p> <p>b, leaking slowly</p> <p>c, no voice of liquid flowing</p>	<p>First find out the point of leaking on tube, and then sealed it, vacuuming it, finally recharge with gas.</p> <p>Note:</p>

	d, cut off charging tube, no gas goes out.	If you find oil on somewhere, it is possible that leakage point is there.
2)There is some thing that blocked the liquid cycle system	<p>A, Ice blocking Sometime because unknown reason water comes into liquid cycle system, the capillary will be blocked by water after unit runs for period of time. Phenomenon of failure: The unit works well in the inception, after period of time the ice appears in the capillary and becomes more and more, till blocks the hole of capillary completely. In the moment you can find the ice on the evaporator defrosts. The noise of liquid flow disappears. The pressure of absorbing becomes negative. The phenomenon above will appear again and again. The way to check ice blocking: Warm the capillary with a hot towel, after a while the ice in the capillary melt, you can hear a sound of gas flow comes from the capillary abruptly. The pressure of absorbing becomes higher. It is Ice blocking.</p>	<p>First stop unit for several minutes, and then open charging tube, discharge all of gas. Blow the cycle system with gas of nitrogen, and then recharge Gas, finally sealed the system.</p>
	<p>B, there is offal block the capillary Phenomenon of failure: If the capillary is blocked by something such as offal etc., the sound of liquid flow disappears. The ice on the evaporator defrosts The pressure of absorbing becomes negative. Higher temperature of discharging tube The way to check offal blocking: If you warm capillary with the way of checking ice blocking, there is no change. It must be offal blocking.</p>	<p>First stop unit for several minutes, and then open charging tube, discharge all of gas. Blow the cycle system with gas of nitrogen. Change a new capillary and filter, and then recharge Gas, finally sealed the system.</p>
COMPRESSOR NEVER STOPS:		
	Reason	Solutions

1)The setting temperature is not reasonable.	Readjust the temperature setting.
2) the sensor is bad.	Replace the sensor.
3)Seal of door is damaged.	Replace the gasket
4)Too much food in the refrigerator	Please put the food properly.
5)Wind door is broken.	Replace wind door.
6)Fan motor is broken.	Replace fan motor

Note:

- Before doing these operations above, disconnect the main power supply. Failure to do so could result in electrical shock or personal injury.
- In case of any detailed technical information please check with the technical specifications.